

Operating Instructions

Controller

B500/B510
C540/C550
P570/P580

M03.0022 ENGLISCH

Original instructions

■ Made
■ in
■ Germany

www.nabertherm.com

Copyright

© Copyright by
Nabertherm GmbH
Bahnhofstrasse 20
28865 Lilienthal
Federal Republic of Germany

Reg: M03.0022 ENGLISCH
Rev: 2022-07

No responsibility is accepted for the correctness of this information. We reserve the right to make technical alterations.

1	Introduction	6
2	Warranty and Liability	7
2.1	General.....	7
2.2	Ambient Conditions.....	8
2.3	Disposal	8
2.4	Product Description	8
2.5	Defined Application.....	9
2.6	Symbols Used in this Manual	9
3	Safety	12
4	Operation	13
4.1	Turning on the Controller/Furnace	13
4.2	Turning off the Controller/Furnace.....	13
5	Construction of the Controller	14
5.1	Arrangement of the Individual Modules of the Controller	14
5.2	Areas of the User Interface	14
5.2.1	Menu Bar	15
5.2.2	“Small Segment Player”	16
5.2.3	“Large Segment Player”	17
5.2.4	Status Bar.....	18
6	Features of the Controller.....	18
7	Operating Instructions Summary B500/B510/C540/C550/P570/P580	21
7.1	Basic Functions.....	21
7.2	Entering a New Program (Program Table)	24
8	Overview Pictures.....	28
8.1	“Furnace” Overview (No Active Program).....	28
8.2	“Furnace” Overview (Active Program)	29
9	Stand-By Mode	31
10	Displaying, Entering or Changing Programs.....	31
10.1	Program Overview	32
10.2	Display and Start Programs	33
10.3	Assign and Manage Program Categories	34
10.4	Enter Programs	36
10.5	Preparing Programs on a PC with NTEdit	44
10.6	Managing Programs (Delete/Copy)	45
10.7	What is a Holdback?.....	46
10.8	Changing a Running Program.....	47
10.9	Performing Segment Jumps	48
11	Setting the Parameters	48
11.1	“Settings” Overview	48
11.2	Measurement Range Calibration.....	49
11.3	Control Parameters	53
11.4	Properties of the Controls	54
11.4.1	Smoothing.....	55
11.4.2	Heating Delay	56

11.4.3	Manual Zone Control.....	57
11.4.4	Integrating the actual value as setpoint for the program start	58
11.4.5	Controlled Cooling (option).....	59
11.4.6	Start-Up Circuit (Output Limit).....	61
11.4.7	Self Optimization.....	62
11.4.8	Charge Control.....	64
11.4.9	Setpoint Offsets for Zones	67
11.4.10	Holdback.....	68
11.5	User Administration.....	68
11.6	Controller Lock and Operation Lock.....	72
11.7	Permanent Lock (Operation Lock)	72
11.7.1	Locking the Controller While a Program is Running	73
11.8	Configuring the Extra Functions.....	74
11.9	Hide or Rename Extra Functions.....	74
11.9.1	Manually Operating Extra Functions During a Running Heating Program	75
11.9.2	Manually Operating Extra Functions According a Heating Program	76
11.10	Alarm Functions	77
11.10.1	Alarms (1 and 6).....	77
11.10.2	Acoustic Alarm (Option)	79
11.10.3	Gradient monitoring.....	80
11.10.4	Examples of Alarm Configuration.....	81
11.11	Network Failure Behavior Settings.....	83
11.12	System Settings.....	84
11.12.1	Setting Date and Time	84
11.12.2	Setting the Date and Time Formats.....	84
11.12.3	Language Setting	85
11.12.4	Setting Display Brightness.....	86
11.12.5	Change Temperature Unit (°C/°F).....	86
11.12.6	Setting the Interface	87
11.12.7	Setting the Wi-Fi Interface.....	90
11.13	Importing and Exporting Process Data, Programs and Parameters.....	91
11.14	Registering Modules	94
11.15	Activating an Air Recirculator.....	95
12	Information Menu	95
13	Process Documentation	97
13.1	Saving Data on a USB Flash Drive with NTLog.....	97
13.2	Saving Process Data and Managing Programs with VCD Software (Option)	101
14	Connecting to the MyNabertherm App.....	101
14.1	Troubleshooting.....	106
15	Communication with the Controller.....	106
15.1	Communication with Superordinate Systems via Modbus TCP	106
15.2	Web Server	106
15.3	Retrofitting a Communication Module	109
15.3.1	Scope of Delivery	109
15.3.2	Installing a Communications Module.....	109

16	Over-Temperature Limiter with Manual Reset (Additional Equipment)	111
17	Potential-Free Contact to Switch On an External Device and Receive Monitoring Signals (Option)	111
18	Error Messages and Warnings	112
18.1	Error Messages of the Controller	112
18.2	Warnings of the Controller	114
18.3	Malfunctions of the Switchgear	117
18.4	Controller Check List.....	118
19	Specifications	120
19.1	Type Plate	122
20	Cleaning	122
21	Maintenance and Spare Times	122
21.1	Replacing a Controller	123
21.2	Removing the Controller Modules.....	123
21.3	Installing the Controller Module.....	124
22	Electrical Connections	124
22.1	Controller Module.....	124
22.2	Power Line Requirements.....	125
22.3	General Connection	125
22.4	Furnaces up to 3.6 kW – Replacement for B130, B150, B180, C280, P330 to 12.2008	126
22.5	Furnaces up to 3.6 kW – Replacement for B130, B150, B180, C280, P330 from 01.2009.....	127
22.6	Furnaces, Single-Zone > 3.6 kW with Semi-Conductor Relay or Protection	128
22.7	Furnaces > 3.6 kW with 2 Heating Circuits	129
23	Nabertherm Service	130
24	For Your Notes	131

1 Introduction

Dear Customer,

Thank you for choosing a quality product from Nabertherm GmbH.

With this system, you have selected a product which is tailored specifically to your manufacturing and production conditions and of which you can be justifiably proud.

This product is characterized by:

- Easy operation
- LCD display with touch function
- Rugged construction
- For use near machinery
- All Nabertherm controllers can be extended with an optional Ethernet interface
- Option for app connection

Your Nabertherm Team



Note

These documents are intended only for buyers of our products and may not be copied or disclosed to third parties without our written consent.

(Law governing copyright and associated protective rights, German Copyright Law from Sept. 9, 1965)

Protective Rights

Nabertherm GmbH owns all rights to drawings, other documents and authorizations, also in case of applications for protective rights.

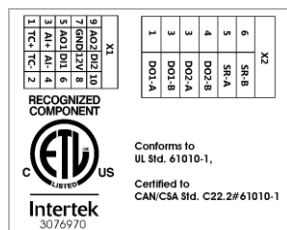

2 Warranty and Liability



As regards warranty and liability, the normal Nabertherm warranty terms apply, unless individual terms and conditions have been agreed. However, the following conditions also apply:

Warranty and liability claims for personal injury or damage to property shall be excluded if they are attributable to one or more of the following causes:

- All persons involved in operation, installation, maintenance, or repair of the furnace must have read and understood the operating instructions. No liability will be accepted for damage or disruption to operation resulting from non-compliance with the operating instructions.
- Not using the furnace as intended
- Improper installation, start-up, operation, or maintenance of the furnace,
- Operation of the furnace with defective safety equipment or improperly installed or non-functioning safety and protective equipment
- Not observing the information in the operating instructions with respect to transportation, storage, installation, start-up, operation, maintenance, or equipping the furnace
- Making unauthorized changes to the furnace
- Making unauthorized changes to the operating parameters
- Making unauthorized changes to the parameterization, the settings, or the program
- Nabertherm accepts absolutely no liability for damage caused by using parts that are not original Nabertherm parts. Original parts and accessories are designed especially for Nabertherm furnaces. Replace parts only with original Nabertherm parts. Otherwise the warranty will be void.
- Catastrophes due to third-party causes and force majeure
- Nabertherm accepts no liability that the controller is free of errors. Purchasers are responsible for ensuring that they make the right choice and also for the consequences of using the controller and the desired or achieved results. Absolutely no liability is accepted for lost data. Nabertherm also accepts no liability for any other damage caused by incorrect performance of the controller. Where legally permissible, Nabertherm will not accept liability for any damage from lost profits, production interruption, data loss, damage to hardware or other damage, regardless of type, resulting from the use of this controller, even if Nabertherm or the retailer was made aware of or informed of the possibility of said damage.

2.1 General

Before working on electrical systems, switch the power switch to "0" and disconnect the power cord.

Even with the power switch off, some parts in the furnace may carry voltage.

Work on the electrical system may only be done by a trained person.

The furnace and switching system have been preset by Nabertherm. If required, process-specific optimization must be carried out in order to achieve the best possible control behavior.

The temperature curve must be modified by the user so that the load, furnace or surroundings are not damaged. Nabertherm GmbH assumes no guarantee for the process.



Caution

Before working on the program-controlled grounding receptacle, the connector (optional series L, HTC, N, LH), or the connected device, always turn off the furnace and disconnect the power cord.

Read the operating instructions for the controller carefully to avoid mistakes or malfunctions in the operation of the controller or the furnace.

2.2 Ambient Conditions

This controller may only be operated if the following environmental conditions have been met:

- Height of the installation site: < 2000 m (sea level)
- No corrosive atmospheres
- No explosive atmospheres
- Temperature and air humidity in conformance with the technical data.

The controller may only be operated with the USB cover is in place, since otherwise dampness and dirt can enter the controller and perfect functionality cannot be ensured.

No warranty is given if the module is dirty because the USB cover was not used correctly or if there was no USB cover.

2.3 Disposal

These controllers contain a battery. This must be disposed of if the battery is replaced or if the controller is disposed of.

Empty batteries do not belong in the garbage. As a consumer, you are legally obliged to return used batteries. You can hand in your used batteries at your local public collection points or anywhere where batteries are sold. Of course you can also return used batteries that we provide to us.



Batteries containing toxic substances are labeled: they show a crossed-out bin and the chemical symbol of the heavy metal necessitating its classification as a source of contamination.

2.4 Product Description

The Series 500 program controller described here provides precise temperature control as well as other functions, such as controlling external process devices. Operation of multi-zone furnaces, charge control and controlled cooling are some examples of the features of this control unit.

Another significant feature is its user friendliness, which is reflected in the operation philosophy, the clear menu design and the clearly structured display. Different menu languages can be chosen for plain text display.

By default, a USB interface is integrated for process documentation and to archive programs and settings. An optional Ethernet interface is available, which enables the controller to be integrated into a local network. Extended documentation, archiving and operation is possible with the optional process documentation software, the VCD software.

The furnace can be observed and malfunction notifications can be received with the MyNabertherm app, which is available for the Android (Version 9 or higher) and iOS (Version 13 or higher) operating systems. The controller is equipped with a Wi-Fi interface, which customers must connect to a Wi-Fi/WLAN network.

2.5 Defined Application

The device is used solely to control and monitor the furnace temperature and to control other peripheral devices.

The device may be used only under the conditions and for the purposes for which it was designed.

The controller may not be modified or converted. It may also not be used to implement safety functions. If the device is used for unauthorized purposes, its operational safety is no longer guaranteed and all warranty claims will be invalid.



Note

The applications and processes described in these instructions are exclusively application examples. The responsibility for the selection of suitable processes and the individual application purpose is the responsibility of the operation.

Nabertherm assumes no warranty for the results of processes described in these instructions.

All the applications and processes described are based only on the experience and knowledge of Nabertherm GmbH.

2.6 Symbols Used in this Manual

Series 500 controllers are divided into a controller in the vertical and one in the horizontal format. The position of the controls can be different for both variants. However, the function of the described control elements is the same.

In these instructions, explanations about how to operate Series 400 controllers are supported by symbols. The following symbols are used:

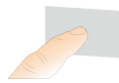

Press the touch panel to select a menu, a parameter to make settings, to change values and to confirm set values. The touch panel is capacitive and cannot be operated with work or safety gloves.



When no program is running, select the “Furnace” icon to see an overview of the furnace status. If a program is running, use the icon to go to the current program progress.



The “Programs” icon is used to edit and select programs.



Optional – The “Archive” icon can be used to display the graphs of the last 16 program runs.



“Settings” is used to access the controller settings.



“Start” starts a heating program.



“Stop” stops an active heating program.



“Pause” pauses an active heating program. The current temperature setpoint is maintained. Extra functions in use remain activated.



“Repeat” restarts the last heating program that has finished. (Press and hold the button)



“Remaining time” shows the remaining time of a program / segment. The time is displayed with [-] in front.



“Expired time” shows the expired time of a program / segment.



“Heating” shows the activity of the heater.



The “Heating” icon changes color depending on the percentage of output power. If controlled cooling is active, the icon is blue.



Press “Process Data” on the segment player to change between actual and setpoint values of all temperature measuring points in tabular format.



“Clock” shows a point in time / a time.



“Warning/Malfunction” shows an active warning or malfunction.



If the “Favorite” icon is filled out, this shows that a heating program has been marked as a favorite.



If the “Favorite” icon is not filled out, this shows that a heating program has not been marked as a favorite.



“Forward” is used to navigate between the segments of a program.



“Back” is used to navigate between the segments of a program.



“Delete” is used to delete programs or segments.



“Multiple Selection” is used to select several programs in one category / segments of a program.



“Select” is used to select/deselect a program / segment. A deselected program / segment is shown with a square.



“Select” is used to select/deselect a program / segment. A selected program / segment is shown with a tick.



“Close” is used to close a selected program / segment.



“Add” is used to add a program / segment.



“Back” is used to navigate in the “Settings” icon and for initial set-up.



“Save” is used to save a program.



“Info” opens context-related help advice.



“Edit” is used to edit a program / furnace name.



When a heating program is active, “Expand” is used to switch from the graphical program view to the graphical segment view.



When a heating program is active, “Collapse” is used to switch from the graphical segment view to the graphical program view.



“Categories” is used to select the program categories.



“Context menu” provides more selection / setting options depending on the page.



The “Extend/Retract” tab is used to extend and retract the segment player, which is achieved by swiping.



The “Extend/Retract” tab is used to extend and retract the header, which is achieved by swiping. Information about Wi-Fi, users and other basic information is shown here.



This segment type icon shows a rising temperature ramp.



This segment type icon shows a falling temperature ramp.



This segment type icon shows a hold time.



This segment type icon shows a rising temperature jump.



This segment type icon shows a falling temperature jump.



“Segment type” shows an end segment.



This icon enables quick selection for a setpoint jump with ramps or an infinite time during hold times. Quick selection can be chosen directly on the key pad.



“Program settings” is used to select a holdback type and to select/deselect charge control in the start menu.



“Charge control” shows a charge control that has been selected in a program.



“Holdback manual” shows the selected holdback type “manual”.



“Holdback extended” shows the selected holdback type “extended”.



“Wi-Fi” shows an active connection with high connection strength.



“Wi-Fi” shows an active connection with low connection strength.



“Wi-Fi” shows that there is no connection.



“Repeat” repeats the program over and over again (see end segment).



“Extra functions” activates selection/deselection of extra functions.



Icon for the user level required for operation (operator, supervisor or administrator)

3 Safety

The controller has a range of electronic monitoring functions. If a malfunction occurs, the furnace switches off automatically and an error message is shown on the display.

The controller has a series of electronic monitoring functions. If a malfunction occurs, the furnace automatically shuts down and an error message appears in the LC display.



Caution

Without additional safety system, this controller is not approved for the monitoring or control of safety-relevant functions.

If the failure of furnace components presents a danger, additional qualified protective measures are necessary.



Note

For more information, please see Chapter "Faults - fault messages"



Note

The behavior of the controller after a grid power outage has been preset as a default setting.

If the grid power outage is shorter than approx. 2 minutes, a running program is continued, otherwise the program is aborted.

If this setting is not suitable for your process, this setting can, as a rule, be adapted to your process (see the section "Setting the Behavior after Power Outage").



Warning! General Hazards!

The Operating Instructions must be followed prior to switching on the furnace.

4 Operation

4.1 Turning on the Controller/Furnace

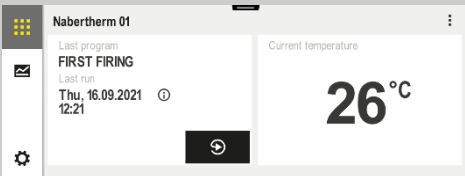
Turning on the controller		
Procedure	Display	Comments
Turn on the power switch		Set power switch to "I". (Power switch type varies according to design/furnace model)
The furnace status is displayed. After a few seconds, the temperature is displayed.		When the temperature is shown on the controller, the controller is ready for operation.

All the necessary settings for perfect functions have already been made at the factory.

If required, heating programs can also be imported by loading a program file onto a USB flash drive.

4.2 Turning off the Controller/Furnace

Turn off the controller		
Steps	Display	Comments
Turn off the power switch		Turn off the power switch by setting it to "0" (power switch type differs depending on features/furnace model)



Note

Stop running heating programs before turning the furnace off at the main switch, since the controller will otherwise generate a fault message when it is turned back on.
 See Faults/fault messages

5 Construction of the Controller

5.1 Arrangement of the Individual Modules of the Controller

The controller consists of the following modules:	
1	Voltage supply
2	Control modules for controlling zones and charges (-103K3/4). One control module per controller.
2a – 2c	Other modules depend on the additional features
	Communication module for USB and Ethernet connections for a PC
3	Operating and display unit (-101A8)

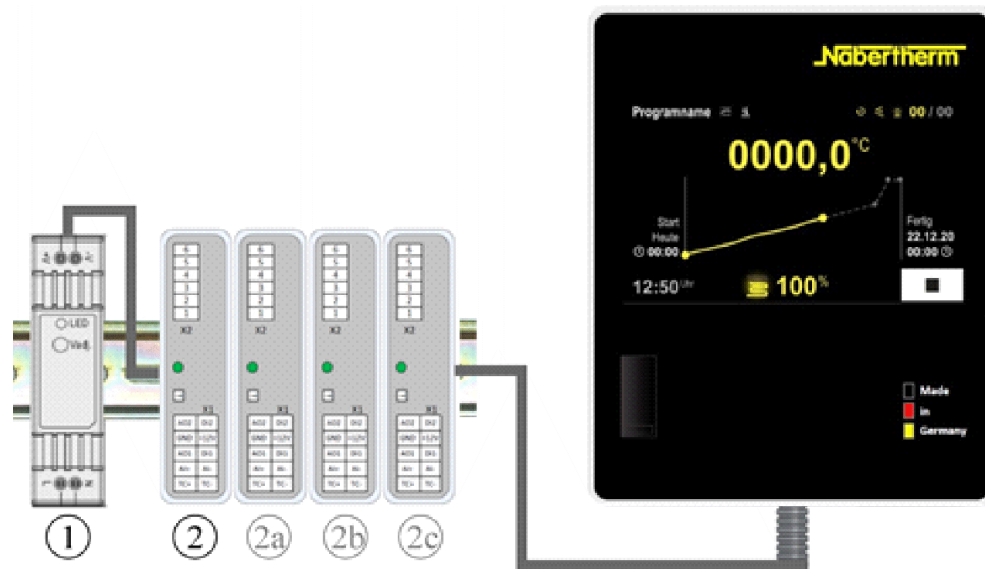

Fig. 1: Arrangement of the individual modules of the controller (similar to picture)

Voltage supply (1) and control modules (2) are located in the switchgear, the operating and display unit (3) can be installed in the front or side of the switchgear or in the front of the furnace. The control modules (2) are coupled via a pluggable connector in the back wall.

5.2 Areas of the User Interface

Series 500 controllers have a convenient and clear user interface. The device has easy to understand operating icons and is split into different operating areas to ensure that operators quickly find the function they are looking for. These basic elements are described below.

5.2.1 Menu Bar

On the left of the user interface are some icons with which operators select the main areas.

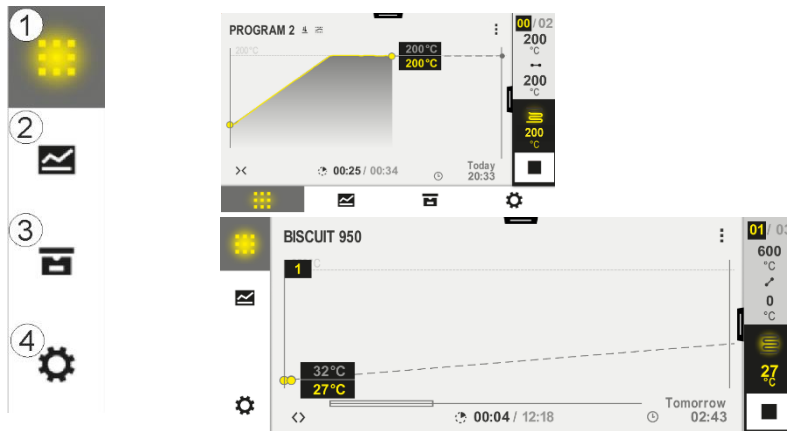

No.	Description
1	Furnace Overview: Shows all the relevant furnace data and graphs while a program is running.
2	Programs: Selection, view, input and management of programs.
3	Archive (optional): Shows completed programs. This icon is not available on all controller models.
4	Settings: Shows settings, such as control parameters, extra functions, measurement section calibration and data recording.

5.2.2 “Small Segment Player”

During an active program, the small segment player is displayed on the right-hand side of the screen. The segment player enables operation of the controller and displays information about the current segment. The segment player is displayed in different operation areas.

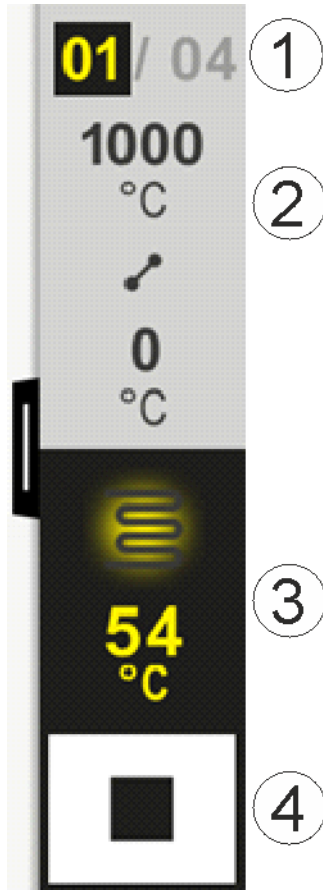

No.	Description
1	Segment display: Left: Current segment number Right: Number of segments in the program
2	Temperature profile of the segment: Top/bottom: Start temperature and target temperature of the current segment in the selected temperature unit Middle: Icon for the temperature profile (rising hold time, hold time and falling hold time)
3	Temperature and heating: Top: Shows active heating. The icon is colored differently depending on the heating output. Value: Current temperature in the master zone in the selected temperature unit
4	Stop button: This button is used to stop the current furnace program at any time.

5.2.3 “Large Segment Player”

The large segment player can be opened during an active program by swiping the small segment players to the left. The small segment players is swiped via a tab on the left-hand side. The large segment player extends the small segment player with additional information about the active segment.

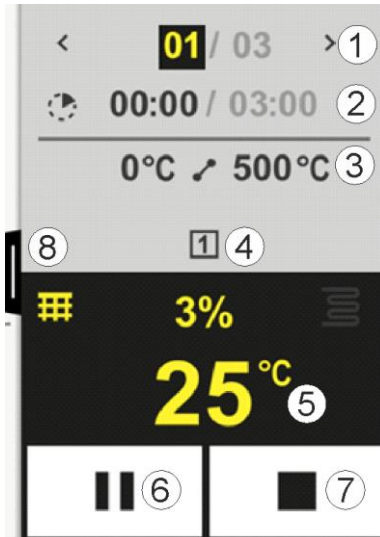

No.	Description
1	Segment display: < : Show previous segment > : Show next segment Left number: Segment currently selected Right number: Number of segments in the program
2	Time details for the selected segment: Time on the left: Remaining time in segment or expired time in segment (switchable) Time on the right: Time of a complete segment Bar: Progress bar for the current segment
3	Temperature profile of the segment: Left: Start temperature of the current segment in the selected temperature unit Middle: Icon for the temperature profile (rising hold time, hold time and falling hold time) Right: Target temperature of the current segment in the selected temperature unit
4	Shows extra functions that are currently active
5	Temperature and heating: Left icon: Button to select the process data table (see “Displaying Process Data”) Middle: Current heating output as a percentage Right icon: Shows active heating. The icon is colored differently depending on the heating output Value: Current temperature in the master zone in the selected temperature unit

6	Program hold button: In ramps: Setpoint is frozen In hold times: Time progress is frozen
7	Program stop button: If selected, operators are asked if they are sure they want to stop the program. If the answer is “YES”, the program is stopped immediately. Press the button until you reach the end of the progress bar. This can take about 2-3 seconds. If you press the button by mistake, simply release it again. The program will then not be stopped.
8	Tab to expand/collapse the segment player

5.2.4 Status Bar

To display the status bar, drag the tab in the middle of the top edge of the screen down. This is possible only when no active program is running.

The status bar provides additional information about the status of Wi-Fi, operator, etc.



No.	Description
1	Date and time
2	Status of the Wi-Fi connection (visible only when a network is connected)
3	Status of a PC connection (visible only when VCD software is connected)
4	Icon for the controller lock (visible only when the controller is locked)
5	Logged in user (e.g., SUPERVISOR; when pressed, go to [User Administration])

6 Features of the Controller

Function		B500/ B510	C540/ C550	P570/ P580
		x = Serial feature o = Option		
	Internal overtemperature protection ¹⁾	x	x	x
Program functions	Programs	5	10	50
	Number of segments	4	20	40
	Segment jump	x	x	x
	Select start time	x	x	x

Function	B500/ B510	C540/ C550	P570/ P580	
	x = Serial feature o = Option			
	Manual holdback function	x	x	x
	Extended holdback function			x
	Extra functions	max. 2	max. 2	max. 6
	Program name to be selected	x	x	x
	Ramps as gradient/rate or time	x	x	x
	Active extra functions, also after the end of the program	x	x	x
	Copy programs	x	x	x
	Delete programs	x	x	x
	Program start at current furnace temperature	x	x	x
Hardware	Thermocouple type B/C/E/J/K/L/N/R/S/T	x	x	x
	Pyrometer input 0-10 V/4-20 mA	x	x	x
	Constant heating control	X	x	x
Controller	Zones	1	1	1 - 3
	Charge control	no	no	o
	Controlled cooling	no	no	o
	Manual heating circuit setting (2nd heating circuit)	o	o	o
	Start-up circuit	x	x	x
	Auto-tune (only single zone)	x	x	x
Documentation	Process documentation NTLog	x	x	x
	Display and record of up to 3 additional thermocouples	no	no	o
Settings	Calibration (max. 10 base points)	x	x	x
	Control parameters (max. 10 base points)	x	x	x
Monitoring	Gradient monitoring (rate of temperature increase)	x	x	x
	Alarm functions (band/min/max)	6	6	6
Other	Controller lock	x	x	x
	Heating delay after door is closed	o	o	o
	User administration	x	x	x
	Changing the time format	x	x	x

Function		B500/ B510	C540/ C550	P570/ P580
		x = Serial feature o = Option		
	Changing between °C/°F	x	x	x
	Adjusting the power failure behavior	x	x	x
	Import/export parameters and data	x	x	x
	Protection function for air circulation ²⁾	o	o	o
	Decimal place can be selected	o	o	o
	Display of PID output for optimization	x	x	x
	Energy meter (kWh) ³⁾	x	x	x
	Statistics (operating hours, consumption values..)	x	x	x
	Real time clock (battery buffered)	x	x	x
	Acoustic signal, parameterizable	o	o	o
	Ethernet data interface	o	o	o
	Operation via touch screen	x	x	x
	Archive view	o	o	o
	Upgrade to P controller	o	o	-

1) When the program starts, the highest temperature that is set in the program is determined. If, during the program, the furnace is 50/122 °C/°F hotter than the highest program temperature, the controller switches the heating and the safety relay off and an error message is displayed.

2) Pre-set function with forced convection furnaces: When a program is started on the controller, the air circulation motor starts. It remains in operation until the program is finished or stopped and the furnace temperature has fallen below a set value (e.g., 80/176 °C/°F).

3) The kWh counter calculates the power theoretically consumed over the time the heater is turned on for a heating program at nominal voltage. However, there may actually be deviations: If the voltage is low, the power consumption displayed will be too high, and for a higher voltage the power consumption displayed will be too low. Aging heating elements may also cause deviations.

7 Operating Instructions Summary B500/B510/C540/C550/P570/P580

7.1 Basic Functions

Print this section in order to have the basic operating instructions at hand at all times.

Beforehand, read the safety instructions in the controller operating instructions.

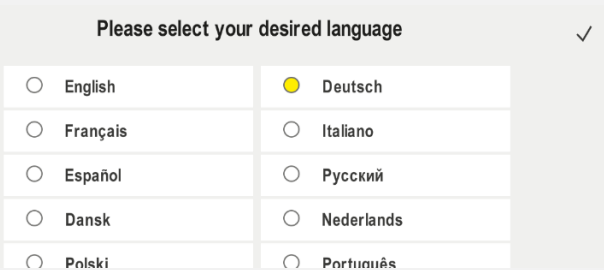
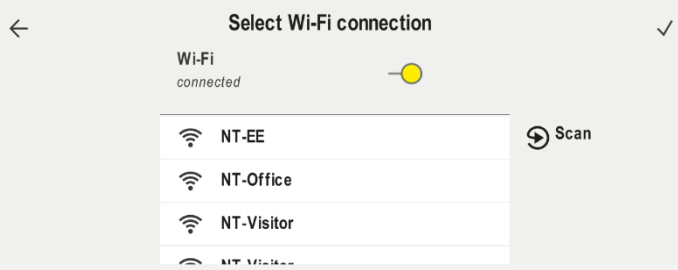
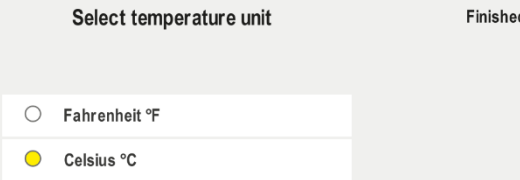
Turn on the controller		
Turn on the power switch.		Set power switch to "I". (power switch type varies according to design/furnace model)
You are in the overview.		
Initial start-up		
Procedure	Operation	Display
When you switch on the furnace, a set-up wizard is opened		The wizard procedure can be repeated if necessary.
Select and confirm language	✓	
Set up the Wi-Fi connection. - Select the correct Wi-Fi network - Enter the Wi-Fi password		
Set up the temperature format	"Finished"	

Change language			
Procedure	Operation	Display	Comments
Select [Settings]			
Select [System] – [Language]. Swipe up if the item is not visible.		In “Settings”, scroll down to “System” on the bottom left-hand side	
Select the desired language			

Load and start the program (if applicable, enter a program beforehand)			
Procedure	Operation	Display	Comments
Select [Programs]			
Select and check the program			
Start program		The controller opens the program overview in graph format with the small segment player.	

Stop a program		
Procedure	Operation	Display
If the controller has not been used for some time, it goes into stand-by mode. Some key information is shown on the dark background. For example, the current temperature, a graph if a program is running, extra functions and other information. Touch the screen anywhere to exit stand-by mode.		
Stop a program in stand-by mode (controller has not been used for some time)		
Confirm the confirmation prompt [End program]	Confirm [Yes]/[No]	Press the button until you reach the end of the progress bar. This can take about 2-3 seconds. If you press the button by mistake, release it again. The program will then not be stopped.
Stop via the segment player		
Confirm the confirmation prompt	Confirm [Yes]/[No]	
Pause program		When the program has been paused, the button flashes until the program is continued (See "Large Segment Player") You have to press this button for longer to rule out an operating error.

7.2 Entering a New Program (Program Table)

Program entry is described in more detail in “Entering or Changing Programs”.

For simple, PC-supported program input and program import via a USB flash drive, please refer to “Preparing Programs on a PC with NTEdit”.

First, fill the program table	
Program name	
Furnace	
Other	

Program options (depending on furnace features).

Activate charge control	

Segment	Temperature		Duration of the segment Time [hh:mm] or rate [°/h]	Additional functions (optional):				
	Start temperature T _A	Target temperature		Controlled cooling	1	2	3	4
1	(0 °)			<input type="checkbox"/>	<input type="checkbox"/>	<input type="checkbox"/>	<input type="checkbox"/>	<input type="checkbox"/>
2	¹⁾			<input type="checkbox"/>	<input type="checkbox"/>	<input type="checkbox"/>	<input type="checkbox"/>	<input type="checkbox"/>
3	¹⁾			<input type="checkbox"/>	<input type="checkbox"/>	<input type="checkbox"/>	<input type="checkbox"/>	<input type="checkbox"/>
4	¹⁾			<input type="checkbox"/>	<input type="checkbox"/>	<input type="checkbox"/>	<input type="checkbox"/>	<input type="checkbox"/>
5	¹⁾			<input type="checkbox"/>	<input type="checkbox"/>	<input type="checkbox"/>	<input type="checkbox"/>	<input type="checkbox"/>
6	¹⁾			<input type="checkbox"/>	<input type="checkbox"/>	<input type="checkbox"/>	<input type="checkbox"/>	<input type="checkbox"/>
7	¹⁾			<input type="checkbox"/>	<input type="checkbox"/>	<input type="checkbox"/>	<input type="checkbox"/>	<input type="checkbox"/>
8	¹⁾			<input type="checkbox"/>	<input type="checkbox"/>	<input type="checkbox"/>	<input type="checkbox"/>	<input type="checkbox"/>
9	¹⁾			<input type="checkbox"/>	<input type="checkbox"/>	<input type="checkbox"/>	<input type="checkbox"/>	<input type="checkbox"/>
10	¹⁾			<input type="checkbox"/>	<input type="checkbox"/>	<input type="checkbox"/>	<input type="checkbox"/>	<input type="checkbox"/>
11	¹⁾			<input type="checkbox"/>	<input type="checkbox"/>	<input type="checkbox"/>	<input type="checkbox"/>	<input type="checkbox"/>
12	¹⁾			<input type="checkbox"/>	<input type="checkbox"/>	<input type="checkbox"/>	<input type="checkbox"/>	<input type="checkbox"/>
13	¹⁾			<input type="checkbox"/>	<input type="checkbox"/>	<input type="checkbox"/>	<input type="checkbox"/>	<input type="checkbox"/>
14	¹⁾			<input type="checkbox"/>	<input type="checkbox"/>	<input type="checkbox"/>	<input type="checkbox"/>	<input type="checkbox"/>
15	¹⁾			<input type="checkbox"/>	<input type="checkbox"/>	<input type="checkbox"/>	<input type="checkbox"/>	<input type="checkbox"/>
16	¹⁾			<input type="checkbox"/>	<input type="checkbox"/>	<input type="checkbox"/>	<input type="checkbox"/>	<input type="checkbox"/>
17	¹⁾			<input type="checkbox"/>	<input type="checkbox"/>	<input type="checkbox"/>	<input type="checkbox"/>	<input type="checkbox"/>
18	¹⁾			<input type="checkbox"/>	<input type="checkbox"/>	<input type="checkbox"/>	<input type="checkbox"/>	<input type="checkbox"/>
19	¹⁾			<input type="checkbox"/>	<input type="checkbox"/>	<input type="checkbox"/>	<input type="checkbox"/>	<input type="checkbox"/>
20	¹⁾			<input type="checkbox"/>	<input type="checkbox"/>	<input type="checkbox"/>	<input type="checkbox"/>	<input type="checkbox"/>

¹⁾ Value is transferred from previous segment (target temperature)

Enter a new program









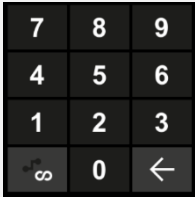

Procedure	Operation	Display

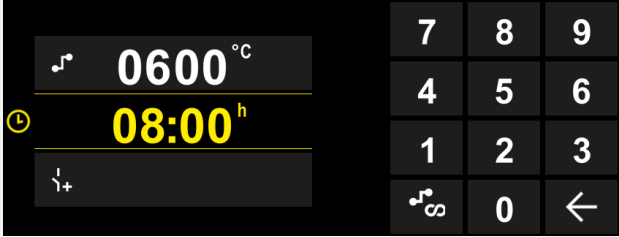
Select [Programs]		
Select either the icon [New program - plus icon] or context menu [New program]		The plus icon is located between the segments.

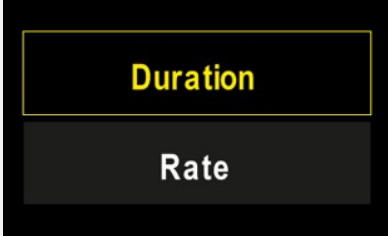
Edit segments

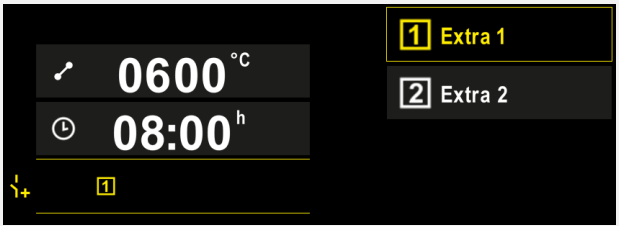
Edit program name, maximum 19 characters.		
---	--	--

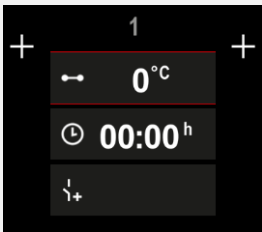

Select the segment to be edited		
---------------------------------	--	--

Enter a new program		
Procedure	Operation	Display
Select and enter the target temperature of the segment		
Enter the duration of the segment.		
Select [Rate] to enter a slope °/h for ramps		
Select/deselect extra functions		
Press segment navigation to select the segment before and after.	 	
Press [+] to add segments		

Repeat the steps described above until you have entered all the segments. Start and end segments are already provided and do not have to be changed, but they do allow entry of special functions.
Extra functions set in the end segment remain after the end of the program until the stop button is pressed again.

Enter a new program		
Procedure	Operation	Display
Save the program: If the program was modified, you will be asked if the program should be saved when exiting the program.		

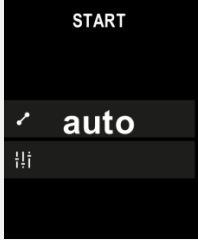
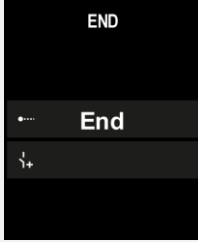
Change other program parameters			SUPERVISOR
Edit program			
Procedure	Operation	Display	Comments
A program consists not only of segments but also a name, a start segment and an end segment. Other parameters can be changed there. In general, these parameters do not have to be changed for simple applications.			
Select [Programs]			
Select a program			
Three-point menu, then [Edit program]			
Change the program name			Special characters as well as upper and lower case are available on separate buttons on the key pad.
Change the holdback type			Choose between [AUTO], [MANUAL] and [EXTENDED – only P570/P580]. See “What is a Holdback”.
Manual			
Extended			
Select a charge control			Charge control can be selected only if the option is available. When this function is activated, the furnace is controlled via a thermocouple near the charge.

Change other program parameters			 SUPERVISOR
Edit program			
Procedure	Operation	Display	Comments
Change the start temperature. In the basic setting, the current furnace temperature is used as a start value for the subsequent course of the program.	auto		See “Using the Actual Temperature as the Program Setpoint at Program Start”.
Change the behavior when the end segment is reached	end		Choose between [END] and [REPEAT]. Choose active extra functions when the program has ended.
Save the program	Press the save icon.		

8 Overview Pictures

8.1 “Furnace” Overview (No Active Program)

The “Furnace” overview provides information about the furnace when no program is running. A special feature is being able to restart the last program that was completed.

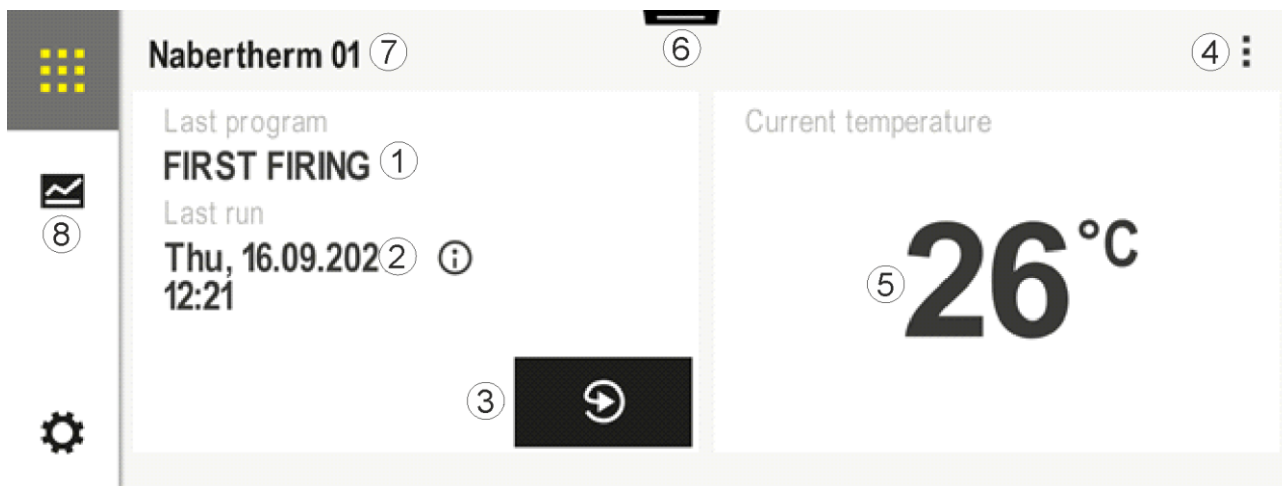

No.	Description
1	Name of the last program that was started
2	Starting time of the last run. The last firing can be viewed via the (i). When the controller is restarted, this data is no longer available.
3	Restart the last program
4	Context menu: <ul style="list-style-type: none"> - Info menu (with service export) - Display app TAN - Display process data - Control extra functions - Edit furnace name - Help icon
5	Shows the current temperature of the master zone.
6	Show status bar (swipe down)
7	Furnace name (can be edited)
8	See "Menu Bar"

8.2 "Furnace" Overview (Active Program)

The "Furnace" overview allows you to observe furnace and program data while a program is running. Segment and furnace data are displayed in the "segment player", which was described above.

If there is a power outage, the old data is no longer available, but all new data is displayed.

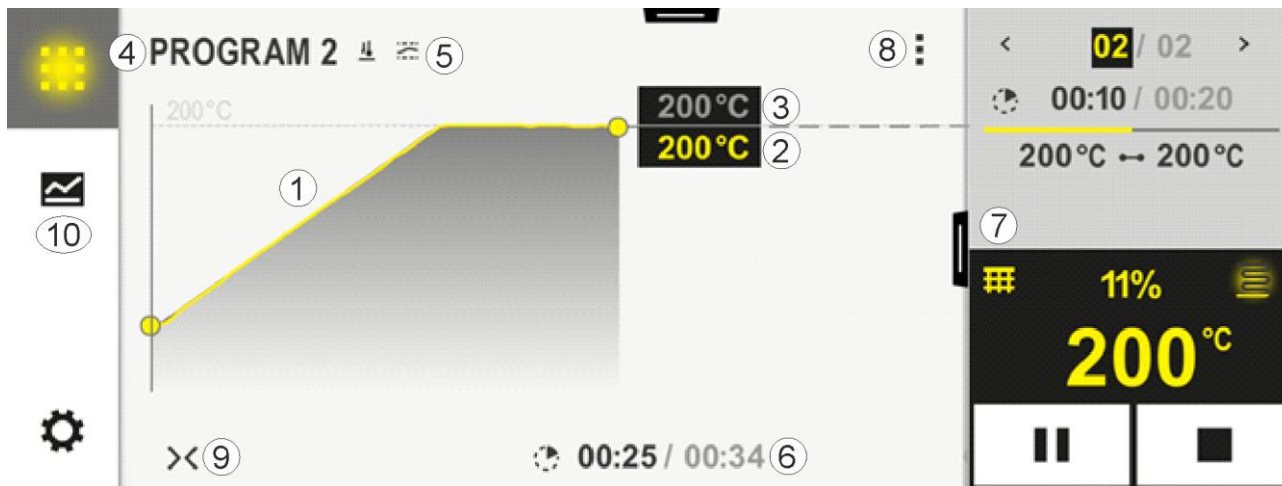

No.	Description
1	Graph of the temperature progress of the active program. The part of the graph marked in yellow and/or filled in gray is in the past. The planned program profile defined in the program is shown to the right of this. If there is a power outage, the old data is no longer available, but all new data is displayed. A new measurement is shown every 30 seconds. Heating programs that take up to 1 week can be displayed. With programs that are longer than 1 week, the first measurements are overwritten.
2	Current furnace temperature
3	Setpoint of the temperature from the furnace program
4	Program name
5	Selected program options, such as charge control or a special holdback type (monitoring function)
6	Display of program times: Remaining time / expired time of the program / approximate time when the program will end
7	Segment player. See “Small Segment Player” and “Large Segment Player”. The small segment player is displayed in the basic setting. Swipe to the left to display the large segment player.
8	Context menu: (Swipe up if not all entries are displayed) <ul style="list-style-type: none"> – Info menu (with service export) – Access the app TAN (access code to pair the MyNabertherm app) – Display process data (access tabular display of process data) – Change active program (does not relate to the saved program) – Control extra functions (change status of the extra functions to start of next segment) – Segment jump – Controller [lock]/[unlock] (lock controller for this program) – Graphs [expand] [collapse] (display all graphs or per segment) – Select graphs (selection of graphs displayed) – Help icon
9	Expand or collapse graphs. When expanding, the graph is expanded from a program view to a segment view. Scaling the graph representation: <ul style="list-style-type: none"> – Maximum length of the graph range: 3 pages – Minimum length of the graph range: 2 pages – Time axis: approx. 0.5cm/h – Minimum length of a segment (also for “STEP”): approx. 1.5cm
10	See “Menu Bar”

If the function for selecting graphs is used, the yellow graph may be replaced by one of the displayed colors. If the furnace has just one heating zone, this selection is empty.

9 Stand-By Mode

A special overview screen is displayed in stand-by mode. The controller goes into stand-by mode if it has not been operated for some time. In stand-by mode, the background lighting is dimmed.

Some of the following content is displayed only when a program is running.

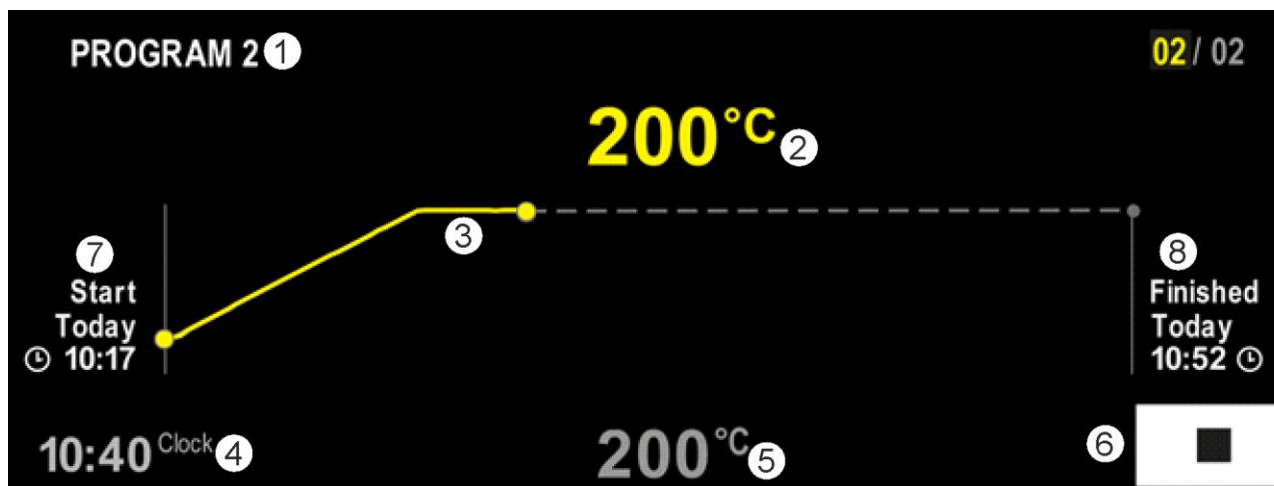

No.	Description
1	Name of the program currently running (only when a program is running).
2	Actual temperature inside the furnace
3	Description of the program currently running (only when a program is running). After a power failure, the graph is deleted and continues only when power is restored.
4	Current time
5	Setpoint of the temperature inside the furnace
6	Stop button to stop the current program (only when a program is running).
7	Start time of the program currently running (only when a program is running).
8	Approximate time when the program will end (only when a program is running).

10 Displaying, Entering or Changing Programs

Programs can be entered or changed quickly with the touch panel. Programs can also be changed, exported or imported from a USB flash drive while a program is running.

Instead of a program number, you can assign a name to each program. If a program is to be used as a template for a different program, it can be copied or deleted easily.

For simple, PC-supported program input and program import via a USB flash drive, please refer to “Preparing Programs on a PC with NTEdit”.



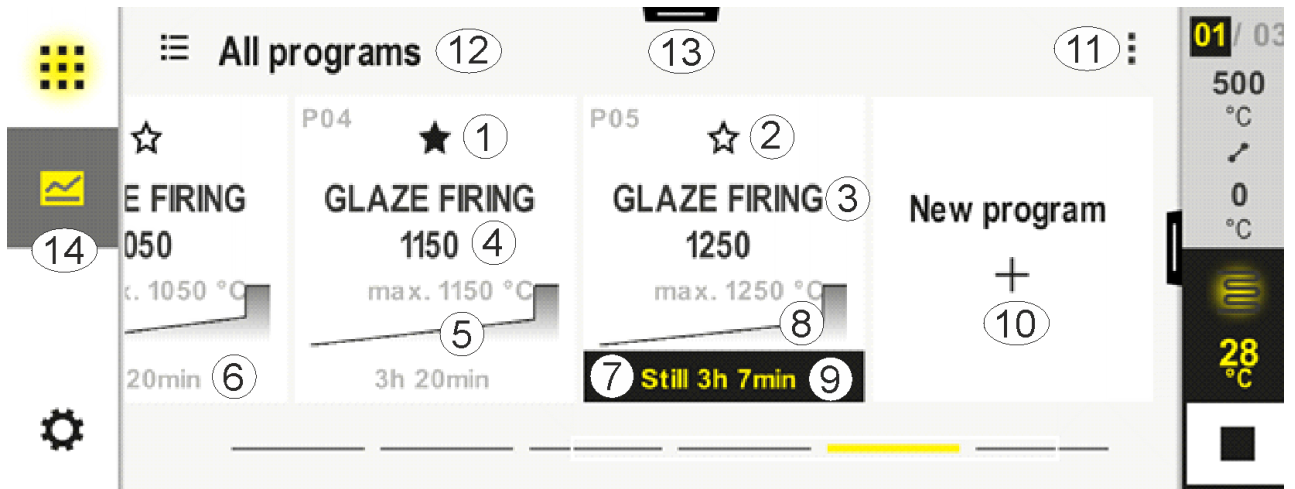



10.1 Program Overview

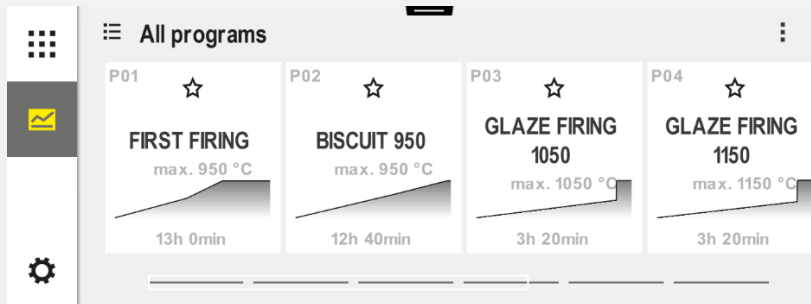

No.	Description
1	Program marked as a favorite
2	Program not marked as a favorite
3	Program name
4	Maximum temperature of the program
5	Graph of the program
6	Expected duration of the program
7	Program that is currently active
8	Graph of the program with indicator of the current processing status
9	Expected remaining time
10	Create a new program
11	Context menu: <ul style="list-style-type: none"> - New program - Help icon
12	Select program category: Press the icon to select the category.
13	Show status bar (swipe down)
14	See "Menu Bar"

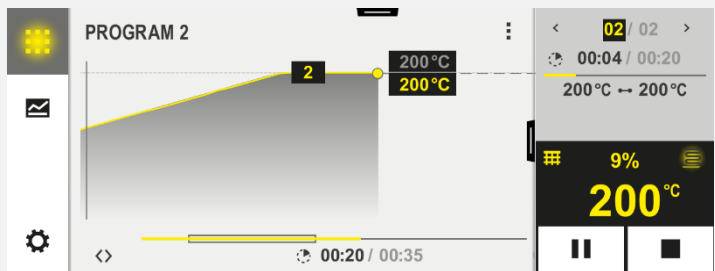

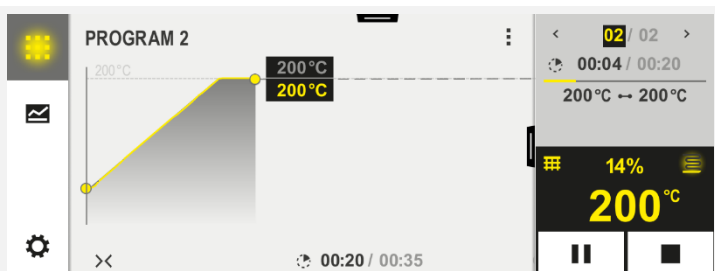

10.2 Display and Start Programs

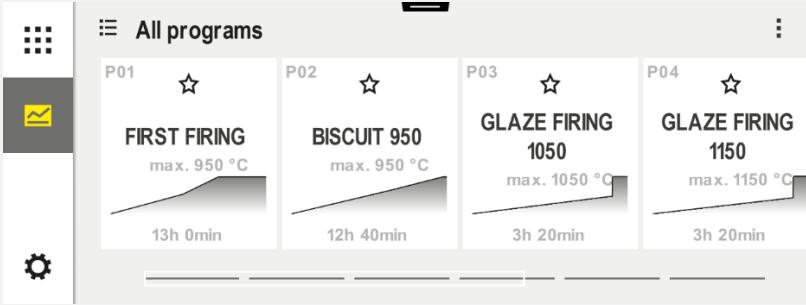

Saved programs can be viewed without accidentally changing the program. To do this, take the following steps:

Display program		
Procedure	Operation	Display/Comment
Select [Programs] menu		
Select a program from the list		
View program in the detail view		
View program in the general overview		
Start program		The selected program can be started from this menu.

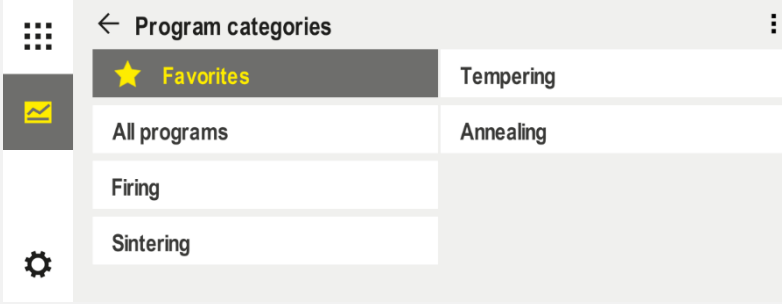
10.3 Assign and Manage Program Categories





So that you can filter programs later in groups, the individual programs can be assigned to a category. To do this, take the following steps:

Filter by program categories		
Procedure	Operation	Display/Comment
Select [Programs] menu		
Select "Categories"		A list of available categories is displayed: 
Select a category from the list and arrow back		All programs in the selected category are displayed

Create, edit and delete program categories		
Procedure	Operation	Display/Comment
Select [Programs] menu		

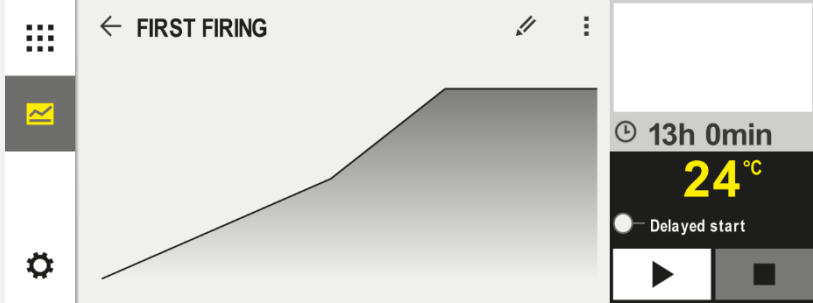
Create, edit and delete program categories		
Procedure	Operation	Display/Comment
Select "Categories"		A list of available categories is displayed:
<i>New category:</i> In the context menu, select "New Category" and then enter the name of the new category		The new category is shown in the list. Up to 6 categories can be entered.
<i>Edit category:</i> Select a category. In the context menu, select "Edit Category"		The name of the category can be changed. On the key pad, use the arrow left button to delete letters. The menu item is available only if an existing category is selected.
<i>Delete category:</i> Select a category In the context menu, select "Delete Category"		

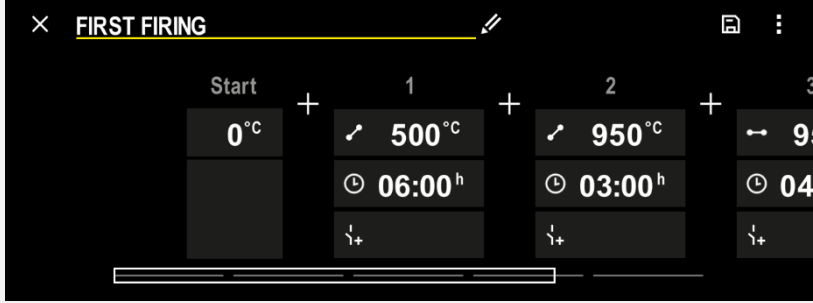
Assign category		SUPERVISOR	
Procedure	Operation	Display	Comments
Select [Programs] menu			

Assign category			SUPERVISOR
Procedure	Operation	Display	Comments
Select program			
To edit: Select the [Edit Program] context menu or select the pencil icon			
Select the [Assign Category] context menu		A list of favorites opens. Select the desired category to display the program in this category.	

10.4 Enter Programs

A program is a temperature profile entered by the user.

Each program has freely configurable segments:

- B500/B510 = 5 programs/4 segments
- C540/C550 = 10 programs/20 segments
- P570/P580 = 50 programs/40 segments (39 segments + end segment)



For simple PC-supported program input and program import via a USB flash drive, please refer to “Preparing Programs on a PC with NTEdit”.

A program consists of 3 parts:

<p>Start segment</p>	<p>The start segment allows input of general program parameters.</p> <p>In the start segment, the start temperature of the program can be selected once. All following start temperatures of the segments are based on the previous segment.</p> <p>Parameters such as charge control and holdback mode (monitoring) can also be activated.</p>
<p>Program segments</p>	<p>The program segments form the program profile. This consists of ramps and hold times.</p>
<p>End segment</p>	<p>Extra functions that are to remain activated after the end of the program can be activated in the end segment. These are reset only when the stop button is pressed again.</p> <p>A function for infinite repetition of the program can also be selected.</p>

Create a new program		SUPERVISOR
Procedure	Operation	Display
Select [Programs] menu		
Either select a tile [New program] or in the context menu select [New program]		

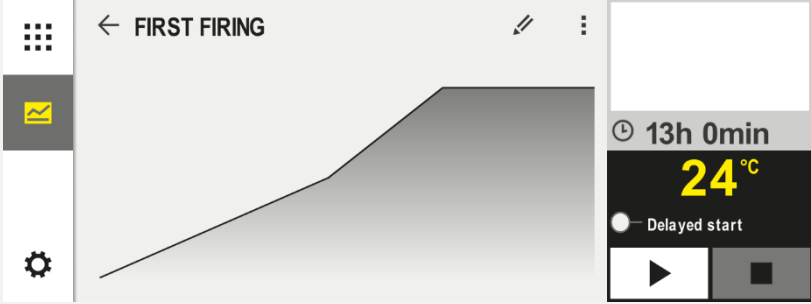
Edit program		SUPERVISOR
Procedure	Operation	Display
Select [Programs] menu		

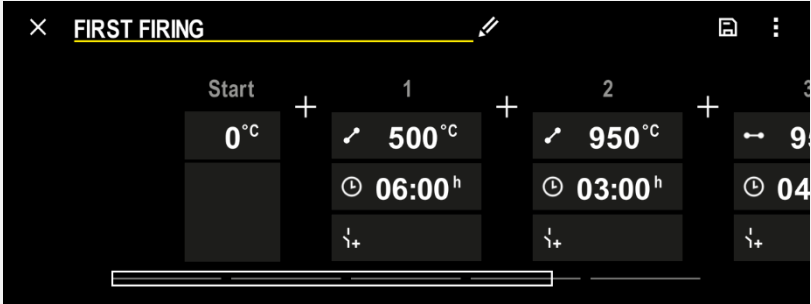
Edit program		SUPERVISOR	
Procedure	Operation	Display	
Select a program			
Change the name of the program: Select the pencil icon beside the program name		Upper and lower case are available on separate buttons on the key pad. Entry must be in Latin letters.	
To edit: Select the [Edit Program] context menu or select the pencil icon			





Start segment – select holdback type		SUPERVISOR	
Procedure	Operation	Display	Comments
Select a program			
Select the start segment			

Start segment – select holdback type			SUPERVISOR
Procedure	Operation	Display	Comments
Change the holdback type	 manual extended		Choose between [AUTO], [MANUAL] and [EXTENDED]. See the description below: “What is a Holdback”.
Exit the start segment			
Save the program			

Start segment - switch on charge control			SUPERVISOR
Procedure	Operation	Display	Comments
Select a program			
Select the start segment			
Select charge control			Charge control can be selected only if the option is available.

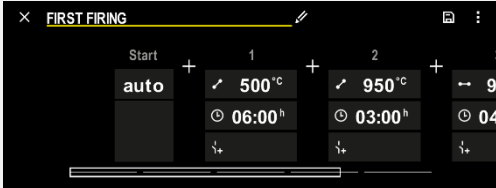
In the start segment, charge control can be activated if a charge thermocouple is installed.

Charge control has major effects on the actual controller. With charge control, the charge thermocouple sends an offset to zone controller, which changes the zone controller until the charge reaches the program setpoint.

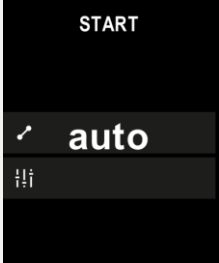
Start segment – change the start temperature			SUPERVISOR
Procedure	Operation	Display	Comments
Select a program			
Select the start segment			
Change the start temperature. In the start segment, select [auto]			<p>The start temperature is a chosen temperature that specifies the starting point of the first segment. It does not necessarily have to be the ambient temperature.</p> <p>Remember that the current furnace temperature can be used as the starting temperature at program start. See “Using the Actual Temperature as the Setpoint at Program Start”. Automatic “use of actual value” is active if “auto” is selected here. When the program is started, the current temperature is then always taken as the start setpoint.</p>

Add and change segments			SUPERVISOR
Procedure	Operation	Display	Comments
Select a program			
Add segments			<p>The [+] icon enables a segment to be added at the respective point between start and end segments, up to the maximum number of segments.</p>

Entering segments with “Holdback mode [MANUAL/EXTENDED]”

If [MANUAL/EXTENDED] is selected for the holdback mode, the entered holdback band is displayed during hold times.

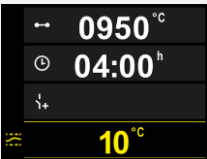

Procedure	Operation	Display	Comments
Only with hold times and holdback mode [MANUAL/EXTENDED]: Set the holdback bandwidth [HB].			Note: Holdback entry [HB] is available only during hold times.

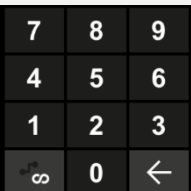
If, for example, a value of “3°” is entered, the temperatures will be monitored in the range +3 ° to -3 ° and the setpoint will be “frozen” when the band is left. If “0°” is entered, the program is not influenced.

Procedure	Operation	Display
Enter the target temperature of the segment		

The target temperature is simultaneously the start temperature of the following segment.

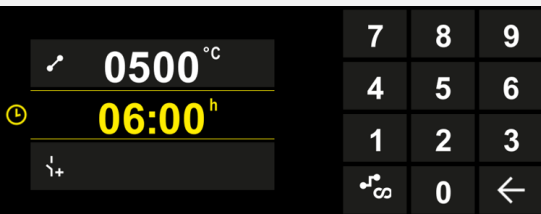
Then a time (for dwell times and ramps) or a rate (for ramps) can be attributed to the segment.

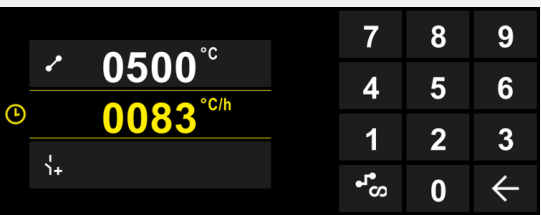
Procedure	Operation	Display
Enter the duration of the segment: With the stairs icon, select the fastest possible increase (step, time = 0:00h). An infinite hold time is set with the [infinite] icon.		
As an alternative to the duration of a segment, it is also possible to enter a rate in °C/h. Here, too, the fastest possible increase is entered via the stairs icon.		

The [Time] is entered in the format hhh:mm.

[RATE] is specified in the format °/h.

Note: With long hold times and activated data recording, the maximum recording time must be considered and, if necessary, process data archiving must be set to [24 h-LONG TERM REC].

If [RATE] is selected: Minimum slope: 1°/h

If [TIME] is selected: Minimum slope: (Delta T)/500h.
 Example: at 10°C temperature difference: 0.02°/h. Gradation: approx. 0.01°

The controller automatically calculates the rate and time at switchover.

Depending on the features of the furnace, external, switchable functions, also called extra functions, are available.

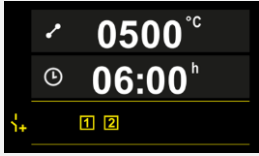

Procedure	Operation	Display	Comments
Select/deselect extra functions			The number of extra functions depends on how the furnace is equipped

Simply select the desired extra function from the list. The number of extra functions available depends on the how the furnace is equipped.

If the furnace is equipped with a cooling fan with variable speed or a controlled flap, these can be used for controlled cooling (see “Controlled Cooling”).

This parameter entry is repeated until all the segments have been entered.

The “end segment” is a special feature in program input. It allows the program to be repeated automatically or extra functions to be set once the program ends.

End segment – functions			 SUPERVISOR
Procedure	Operation	Display	Comments
Set the behavior of the End segment: - Program end - Repeat program.			If “Repeat program” is selected, the selected program is started again directly once the program ends.
Set the behavior of the end segment: - Extra functions after program end			Extra functions set in the end segment remain after the end of the program until the stop button is pressed again.

If “Repeat” is set in the end segment, the complete program is repeated over and over again after the end segment; it can be stopped only by pressing the stop button.

Organize segments			SUPERVISOR
Procedure	Operation	Display	Comments
Select a program			
Select the [Organize Segments] context menu			
Select segments	Select one or more segment tiles.		Press the tile again to deselect.
Move segments	After selecting a segment: use the arrows to select the destination	The segment is moved to the chosen location.	
Select all segments		All segments in the program are selected, apart from the start and end segments	This function can also be selected in the context menu (“All Segments”)
Delete selected segments		The selected segments are deleted.	

Assign category			SUPERVISOR
Procedure	Operation	Display	Comments
Select a program			
Select the [Assign Category] context menu		A list of favorites opens. Select the desired category to display the program in this category.	

When all parameters have been entered, decide whether you want to save the program or exit without saving.

Save program			 SUPERVISOR
Procedure	Operation	Display	Comments
Save the program			When your try to exit the program without saving it, you will be asked if you want to save it.

When the entries are complete, the program can be started (see “Starting a Program”).

If no buttons are activated for some time, the display returns to the overview.

For simple, PC-supported program input and program import via a USB flash drive, please refer to “Preparing Programs on a PC with NTEdit”.

10.5 Preparing Programs on a PC with NTEdit

Entering the required temperature curve is simplified considerably by using software on the PC. The program can be entered on the PC and then be imported to the controller with a USB flash drive.

This is why Nabertherm offers a valuable aid with the freeware **NTEdit**.

The following features support you in your day-to-day work:

- Selecting your controller
- Filtering of extra functions and segments depending on the controller
- Setting extra functions in the program
- Exporting a program to a hard disk (.xml)
- Exporting a program to a USB flash drive for direct import into the controller
- Graphical display of the program sequence



Note

If you do not have a functioning USB flash drive, you can purchase one from Nabertherm (part number 524500024) or download a list of tested USB flash drives. This list is part of the download file for the NTLog function (see information in “Saving Data on a USB Flash Drive with NTLog”). The corresponding file is called: “USB flash drives.pdf”.



Note

This software and the corresponding documentation for NTEdit can be downloaded at the following address:

<http://www.nabertherm.com/download/>

Product: NTEdit

Password: 47201701

The downloaded file has to be unzipped before you can use it.

Before using NTEdit, read the instructions, which are also in the directory.

System requirements: Microsoft EXCEL™ 2010, EXCEL™ 2013 or Office 365 for Microsoft Windows™.

10.6 Managing Programs (Delete/Copy)

Besides the entry of programs, it is also possible to delete or copy them.

Delete programs			SUPERVISOR
Procedure	Operation	Display	Comments
Select [Programs] menu			
Select a program			
Select the context menu and [Delete Program]			
Confirm the confirmation prompt	Yes/No		

Copy programs			SUPERVISOR
Procedure	Operation	Display	Comments
Select [Programs] menu			
Select a program			
Select the context menu and [Copy Program]			
Copy			The program to be copied is written to an empty program slot. If there are no empty program slots, the program cannot be copied.

10.7 What is a Holdback?

A holdback is a temperature band around the program setpoint. Should the actual value drift outside this band the holdback function will pause the setpoint adjuster and remaining time – and maintain the current setpoint value – for as long as necessary for the actual value to return within the temperature band.

The holdback cannot be applied if the processes have to be completed following a precise time specification. The delay of a segment by a holdback is not acceptable, for example, when the actual value approaches the setpoint slowly or there are delay effects in multi-zone controls/charge controls.

Holdback only affects the master zone in “Auto” and “Manual” modes. The other control zones are not monitored.

With “Extended” holdback, the selected control zones are monitored. This function is not yet available in the VCD software.

The holdback monitoring is only possible in dwell times.

In “Auto” and “Manual” modes, for charge control the charge thermocouple is the control zone for the holdback.

There are 3 holdback modes:

Holdback = AUTO: There are no effects of a holdback on the program except when switching over from ramps to dwell times. Here, the controller waits for the dwell time temperature to be achieved. The program waits at the end of a ramp for the dwell time temperature to be reached. Once the dwell time temperature is reached the controller jumps into the next segment and the processing is continued.

Holdback = EXTENDED (only P570/P580): When ramps switch over to hold times, the controller waits until the hold time temperatures are reached in all selected control zones. When the hold time temperature is reached in all selected zones, the controller jumps to the next segment and processing continues.

If a control zone leaves the entered holdback band after it has been reached, a warning message is generated referring to the zone leaving the positive or negative band.

Note: The evaluation that a temperature has entered this band is reset if there is a power failure. During a power failure, there is no message that temperatures are out of the band.

Note: If a thermocouple in this band that is used to monitor the extended holdback breaks, in addition to the warning about the breakage, another warning is output: “Out of under-temperature band”.

Note: The charge measuring point should be monitored only in programs with active charge control. Otherwise, the program cannot run correctly.

Note: The cooling measuring point should be monitored only in furnaces with a separate cooling thermocouple. Otherwise, monitoring cannot be carried out correctly.

Holdback = MANUAL: A tolerance band can be entered for each hold time. If the temperature of the master zone (or the charge thermocouple with charge control) leaves the band, the program is stopped (Hold). The program continues when the master zone is in the band again. If 0 °C is entered as the band, the program is not stopped and is time-controlled, regardless of the temperatures that are measured.

This band does not work in ramps and prolongs the hold time when the temperature leaves the band.

If the value entered is "0", the program works "purely time-controlled". No influence of the program takes place.

Parameter Entry:

In program input, operators can set the holdback to “Auto”, “Manual” or “Extended” in the start segment (program-wide parameters).

10.8 Changing a Running Program

A running program can be changed without ending it or changing the saved program. Remember that no past segments can be changed unless you again go to the desired segment, using the function [SEGMENT JUMP].

Note: With a manual segment leap it may happen that more than one segment is skipped per leap. This depends on the current temperature of the furnace (automatic application of actual value).







Note

Changes made to a running program remain only until the program is finished. The changes (including hold function) are deleted when the program is finished or if there is a power outage during the program.

If the current segment is a ramp, the current actual value after the program change, is accepted as a setpoint and the ramp is continued at this point. If a current dwell time is changed, then a change in the running program has no impact. Only a manual segment jump into this segment results in the execution of a change in the dwell time. The changes on following dwell times are executed without any restrictions.

The following steps must be performed to change an active program:

Change current program			 SUPERVISOR
Procedure	Operation	Display	Comments
Select [Furnace]			
Select the context menu			
Select [Change Active Program]			This can be selected only when a program is running. The administrator can block access to this function for supervisors in the settings.

When a program is active only individual segments can be changed. Global parameters such as the holdback operating mode and charge control cannot be changed.





After saving the change, the program is continued at the time of the change.

10.9 Performing Segment Jumps

Besides changing a program, it is also possible to jump between the segments of a running program. This can make sense if, for example, a dwell time needs to be shortened.

Note: With a manual segment jump it may happen that more than one segment is bypassed per step, even if this was not intended. This depends on the current temperature of the furnace (automatic application of actual value).

The following steps must be taken to execute a segment step:

Carry out a segment jump			 SUPERVISOR
Procedure	Operation	Display	Comments
Select [Furnace]			
Select the context menu			
Select [Segment Jump] and enter the target segment			The administrator can block access to this function for supervisors in the settings.

11 Setting the Parameters

11.1 “Settings” Overview

The controller can be modified in “Settings”. Only Nabertherm can access the “Service” parameter group. The individual parameter groups can be swiped up so that the lower groups become visible.

If certain parameter groups are not visible, swipe the picture up.

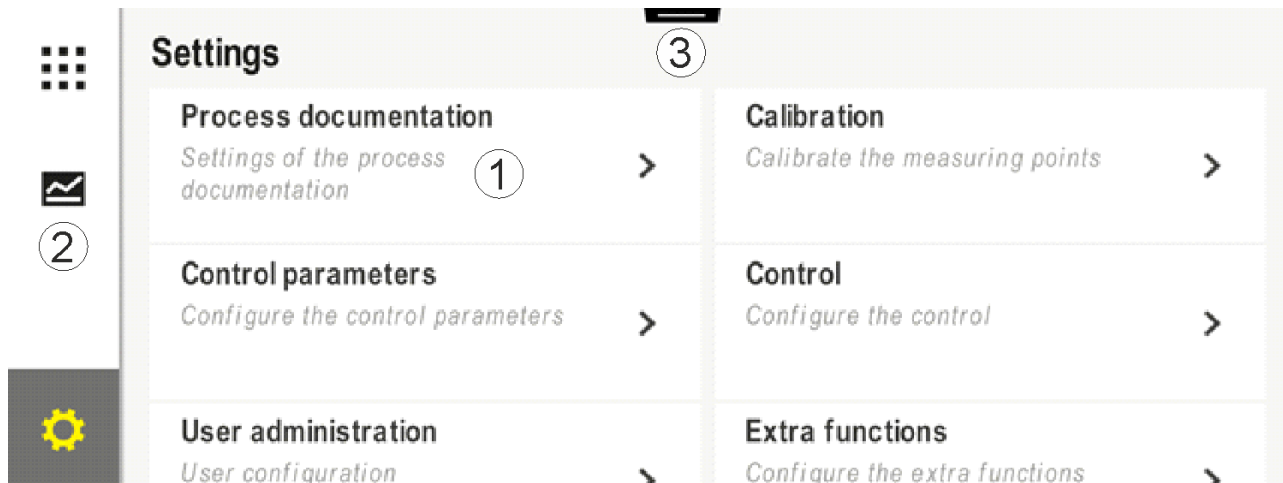

No.	Description
1	Tiles for the setting groups. Select a group to open a sub-menu with the respective settings.
2	See “Menu Bar”
3	Actuating element for the status bar (swipe down to make it visible)

11.2 Measurement Range Calibration



Note

This correction function corresponds to “instrument correction offsets” according to AMS 2750F.

The measurement range from the controller to the thermocouple can exhibit measurement errors. The measurement range consists of the controller inputs, the measurement wires, sometimes terminals and the thermocouple.

If you discover that the temperature value on the controller display no longer agrees with the value of a comparison measurement (calibration), this controller offers the option of an easy matching of the measurement values for each thermocouple.

By entering up to 10 base points (temperatures) with the relevant offsets these temperatures can be matched very flexibly and precisely.

When an offset of a grid point is entered, the actual value of the thermocouple and the entered offset are added.

Examples:

- **Adaptation using a comparative measurement:** The control thermocouple outputs a value of 1000 °C. Calibration measurements near the control thermocouple return a temperature value of 1003 °C. By entering an offset of "+3 °C" at 1000 °C, this temperature is raised by 3 °C and the controller, then also returns a value of 1003 °C.
- **Adaptation using a transducer:** Instead of the thermocouple, a transducer supplies the measurement range with an actual value of 1000 °C. The display outputs a value of 1003 °C. The deviation is "-3 °C" from the reference value. Hence, the offset that must be entered is "-3 °C".
- **Adaptation using a calibration certificate:** On the calibration certification (for example for a thermocouple) there is, at 1000 °C, a deviation of "+3 °C" from the reference value. The correction is "-3 °C" between the display and the reference value. Hence, the offset that must be entered is "-3 °C".
- **Adaptation using a TUS measurement:** During a TUS measurement, a deviation of the display from the reference band of "-3 °C" is determined. Here, the offset that must be entered is "-3 °C".



Caution

The thermocouple calibration certificate does not take into account the deviations of the measurement range. Deviations of the measurement range must be determined by a measurement range calibration. The two values are added together to produce the correction values that need to be entered.



Caution

Please observe the instructions at the end of the section.

The setting function in this instance follows specific rules:

- The values between two support points (temperatures) are linearly interpolated. That means that a straight line is projected between the two values. The values between the supporting points are then on this line.
- The values below the first support point (for example, between 0 and 20 °C) are located on a straight line that is connected (interpolated) with 0 °C.
- Values above the last supporting point (for example >1800 °C) are project further with the final offset (a final offset at 1800 °C of +3 °C is also used at 2200 °C)
- Temperature inputs for the support points must be in ascending order. Support points that follow gaps ("0" or a lower temperature for a support point) are ignored.

Example:

Use from only one supporting point

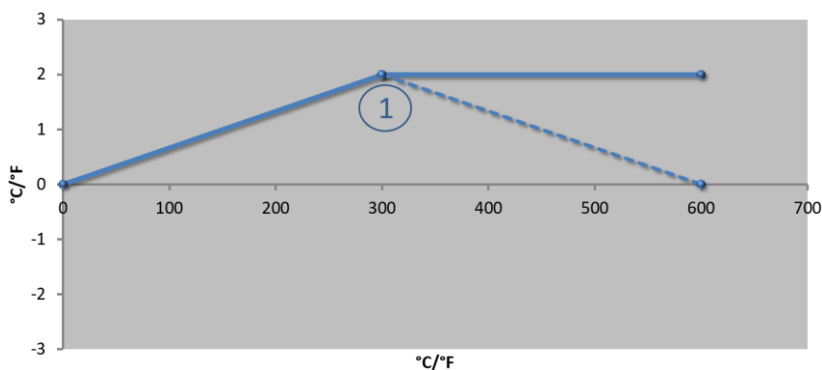

No.	Meas. Point	Offset
1	300.0°	+2.0°
	0.0°	0.0°
	0.0°	0.0°
	0.0°	0.0°
	0.0°	0.0°
	0.0°	0.0°
	0.0°	0.0°
	0.0°	0.0°
	0.0°	0.0°

Similar to picture

Comments: The offset is continued beyond the final supporting point. The gradient of the dashed line would be achieved by entering an additional line with an offset of 0.0 °C at 600.0 °C.

Use of only one offset for several supporting points

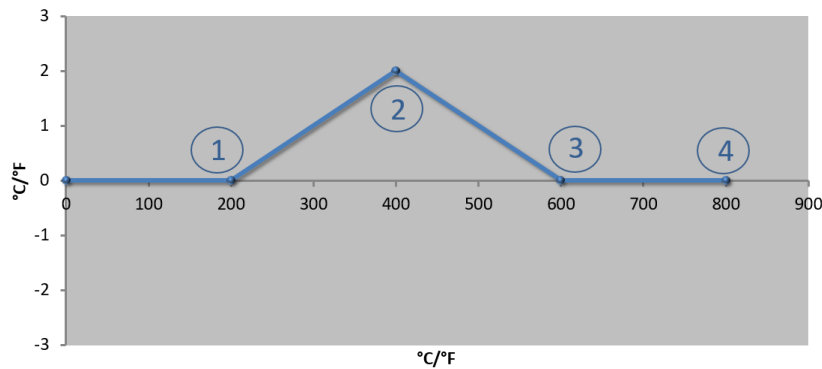

No.	Meas. Point	Offset
1	200.0°	0.0°
2	400.0°	+2.0°
3	600.0°	0.0°
4	800.0°	0.0°
	0.0°	0.0°
	0.0°	0.0°
	0.0°	0.0°
	0.0°	0.0°
	0.0°	0.0°

Similar to picture

Comments: When several supporting points are entered, but only one offset, the result is that to the left and right of this supporting point the offset has the value "0". This can be recognized at the points 200 °C and 600 °C.

Use of 2 supporting points

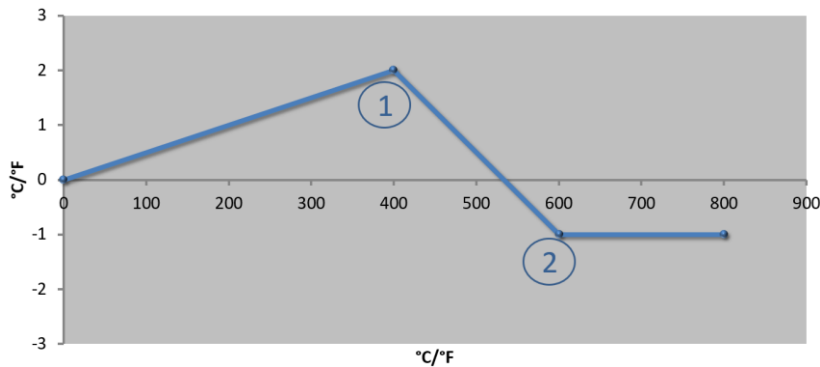

No.	Meas. Point	Offset
1	400.0°	+2.0°
2	600.0°	-1.0°
	0.0°	0.0°
	0.0°	0.0°
	0.0°	0.0°
	0.0°	0.0°
	0.0°	0.0°
	0.0°	0.0°
	0.0°	0.0°

Similar to picture

Comments: If two supporting points are entered, each with an offset, there is an interpolation between the offsets (see points 1 and 2).

Use of only two offsets for several supporting points

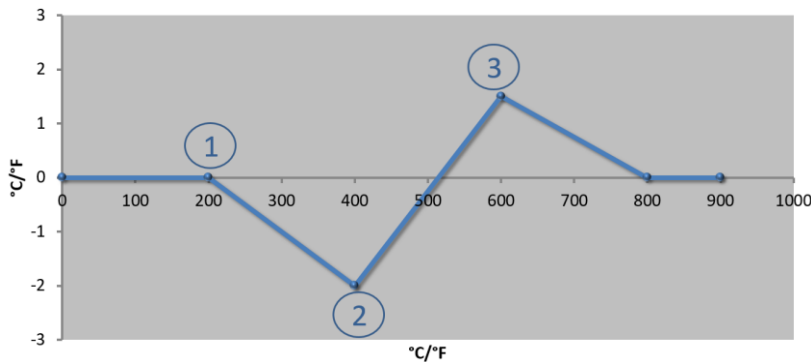

No.	Meas. Point	Offset
1	200.0°	0.0°
2	400.0°	-2.0°
3	600.0°	+1.5°
	800.0°	0.0°
	0°	0°
	0°	0°
	0°	0°
	0°	0°
	0°	0°
	0°	0°

Similar to picture

Comments: Here, too, the range around the offsets entered can be eliminated again.

Use of several supporting points with separated offsets

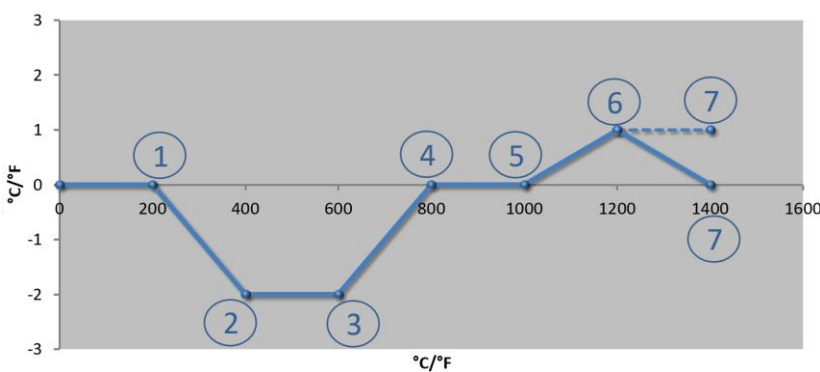

No.	Meas. Point	Offset
1	200.0°	0.0°
2	400.0°	-2.0°
3	600.0°	-2.0°
4	800.0°	0.0°
5	1000.0°	0.0°
6	1200.0°	1.0°
7	1400.0°	0.0°
	0.0°	0.0°
	0.0°	0.0°

Similar to picture

Comments: If the final line were left out, the gradient of the dashed line would reach (1400.0 °C). The offset would then continue beyond the final supporting point.







Notice

This function is intended for setting the measurement section. If deviations outside the measurement section are to be balanced out, for example, temperature uniformity measurements inside the furnace, the actual values of the corresponding thermocouples are falsified.

We recommend that you create the first base point at 0 ° with an offset of 0 °.

When you have set a measuring point, you must always carry out a comparison measurement with an independent measurement device. We recommend that you document and file changed parameters and comparison measurements.

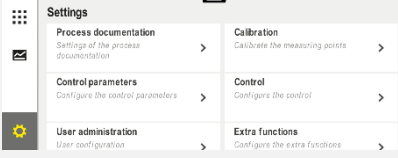
The following steps must be performed to set the measurement range calibration:

Calibrate measuring point			 ADMINISTRATOR
Procedure	Operation	Display	Comments
Select [Settings]			
Select [Calibration]			
Select the measuring point (zone)	For example [Master]		Each measuring point has its own calibration menu. The current temperature of the respective measuring point is also shown at the top right-hand side
If required: Change the base point	e.g., select base point 1 (e.g., 400°)	Entry field for the base point	
Change correction value	Select correction value	Entry field for correction	You can also enter a negative value
Save or cancel the entry	✓ or ✗		When you exit the page or change to a different measuring point, the data entered is saved automatically. After saving, open the page again to check that all the changes were entered correctly.
Repeat this procedure for the other measuring points			
Exit the menu	←		The values are saved automatically after they have been entered.

11.3 Control Parameters

Control parameters define the behavior of the controller. For example, the control parameters influence the speed and accuracy of control. This allows users to adjust the controls to suit their particular requirements.

This controller provides a PID controller. The output signal of the controller consists of 3 parts:

- P = proportional portion
- I = integral portion
- D = differential portion

Proportional Portion

The proportional portion is a direct reaction to the difference between the setpoint and the actual value of the furnace. The larger the difference, the larger the P-portion. The parameter that influences this P-portion is the parameter "X_p".

Here the following applies: The larger the "X_p", the smaller the reaction to the deviation. So it acts inversely proportional to the control deviation. At the same time, this value describes the deviation, for which the P-portion rises to = 100 %.

Example: A P controller should, for a control deviation of 10 °C, output a power of 100 %. X_p is therefore set to "10".

$$Power [\%] = \frac{100\%}{X_P} \cdot Deviation [^{\circ}C]$$

Integral Portion

The integral portion grows as long as a control deviation is present. The speed at which this portion grows is determined by the constant T_N. The bigger this value is, the more slowly the I-portion increases. The I-portion is set using the parameter [T_I] unit: [Seconds].

Differential Portion

The differential portion reacts to the change in the control deviation and works against it. If the temperature in the furnace approaches the setpoint, the D-portion acts against this approach. It "dampens" the change. The D-portion is set using the parameter [T_D] unit: [Seconds].

The controller calculates a value for each of these percentages. Then all three percentages are added together and the result is the power output of the controller for this zone in percent. Whereby, the I- and D-portions are each limited to 100 %. The P-portion is not limited.

Display of the Controller Equation

$$F(s) = \frac{100\%}{X_P} \cdot \left[1 + \frac{1}{T_N \cdot s} + \frac{T_v \cdot s}{T_{cyc}} \right]$$

Integrating PID parameters from B130/B150/B180/C280/C290/P300-P310 controllers (index 2) for Series 500 controllers (index 1)



The following factors must be used to integrate the parameters:

$$x_{p1} = x_{p2}$$

$$T_{i1} = T_{i2}$$

$$T_{d1} = T_{d2} \times 5.86$$

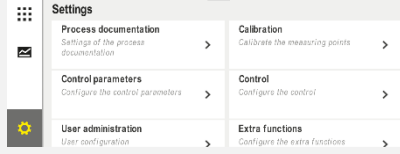
The following steps must be taken to set the control parameters:

Calibrate measuring point			ADMINISTRATOR
Procedure	Operation	Display	Comments
Select [Settings]			
Select [Control Parameters]			
Select the measuring point	E.g., Master		The selection depends on the equipment of the furnace.
Select [Base Points]			
If required: Set base points 1-10	E.g., 400°-800°	Entry field for PID parameters	Based on the base points, you can choose the temperature range for which the parameters are to be set. The number of base points can be freely selected (up to 10).
Repeat the procedure for other measuring points			
Exit the menu			The values are saved automatically after they have been entered.



Caution

The I-portion is only enlarged until the P-portion has reached its maximum value. From then on the I-portion is no longer changed. In certain situations, this can prevent major overshooting.



Note

The control parameters are set in the same way as for Nabetherm controllers B130/B150/B180, C280 and P300-P330. If a controller is replaced, the controller settings can be transferred and then be optimized. Series 400 controllers (B400, B410, C440, C450, P470, P480) use the same control parameters as Series 500 controllers (B500, B510, C540, C550, P570, P580).

11.4 Properties of the Controls

This section describes how to adjust integrated controllers. Depending on the features, controllers are used for zone heating, charge control and controlled cooling.

11.4.1 Smoothing

A heating program usually consists of ramps and dwell times. Overshooting is a likely possibility when the program progresses from one segment to the next. In order to dampen this tendency to overshoot, the ramp can be "smoothed" just prior to the transition into the dwell time.

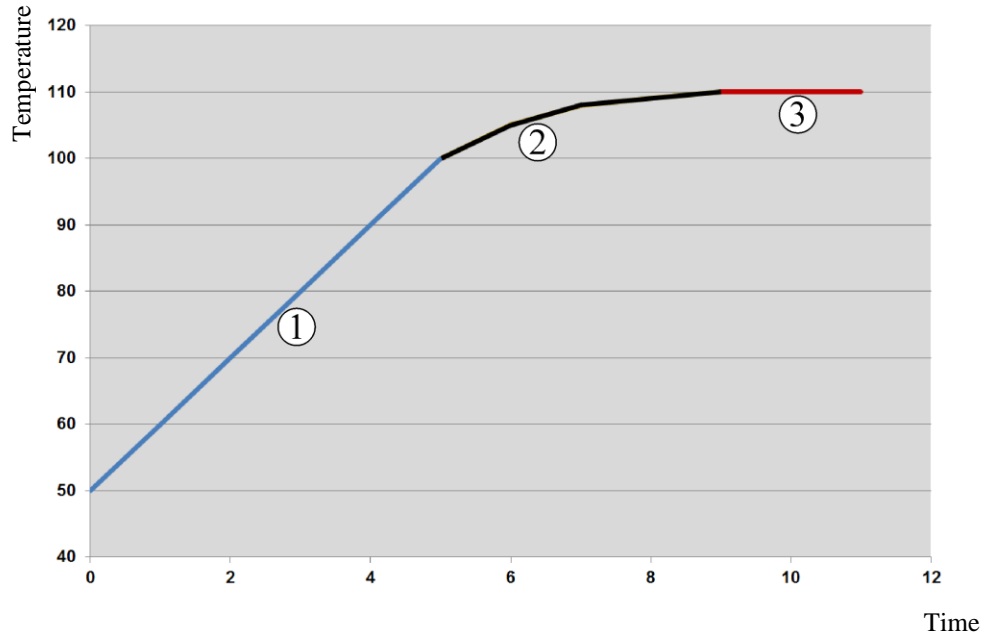

Fig. 2: Smoothing the ramp time

Range	Explanation
1	Normal course of the ramp
2	Smoothed range of the ramp
3	Normal dwell time





Caution

The ramp time can be extended when this function is activated, depending on the smoothing factor.

The following steps must be performed to set the smoothing parameters:

Set smoothing			ADMINISTRATOR
Procedure	Operation	Display	Comments
Select [Settings]			
Select [Control]			

Set smoothing			 ADMINISTRATOR
Procedure	Operation	Display	Comments
Select [General]			
Select [Smoothing] and set the smoothing factor			
Save			The changes are saved automatically when you exit the menu.



Caution

Calculation of the smoothing:

In case of a setpoint jump, the setpoint reaches, with a smoothing time of 30 seconds, after 30 seconds, 63 % of the target setpoint and, after 5 x 30 seconds, 99 % of the target setpoint.







Equation:

$$\text{Set value } (t) = 1 - e^{-t/\tau}$$

11.4.2 Heating Delay

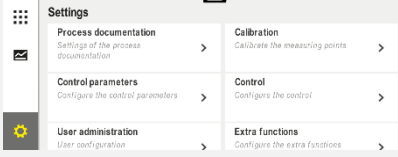
If a furnace is loaded hot and with the door open, the cooling of the furnace will result in intensive reheating and overshooting after the door has been closed.

This function can delay the switching on of the heating so that the heat stored in the furnace first raises the temperature in the furnace again. If the heating switches on again after the delay time, the heating need not reheat the furnace as much and overshooting is avoided.

Set heating delay			 ADMINISTRATOR
Procedure	Operation	Display	Comments
Select [Settings]			
Select [Control]			
Select [General]			
Select [Heating Delay] and set the delay time			
Save			The changes are saved automatically when you exit the menu.



Caution

In order to be able to use this function the door switch signal ("Door closed" = "1" signal) must be connected to an input of the controller module. The setting of the corresponding input can only be performed in the service level and, hence must be set before the controller leaves the factory.

11.4.3 Manual Zone Control

It is possible that for furnaces with 2 heating circuits that do not have their own multi-zone control, different output powers are needed.

Using this function you can individually adapt the power of two heating circuits to the process. The controller has two heating outputs whose ratio in relation to each other can be set differently by the optional reduction of one output power. When shipped from the factory, both heating outputs are set to 100 % output power.

The setting of the ratios of the two heating circuits and their output powers are shown in the following table:





Display	0	10	20	30	40	50	60	70	80	90	100	110	120	130	140	150	160	170	180	190	200
A1 in %	0	10	20	30	40	50	60	70	80	90	100	100	100	100	100	100	100	100	100	100	100
A2 in %	100	100	100	100	100	100	100	100	100	100	100	90	80	70	60	50	40	30	20	10	0

Example:

- 1) At the setting "200", the furnace is heated only through output 1 (**A1**), for instance for a furnace for fusing applications, if only the ceiling heater is to be used and the side or floor heater is to be turned off. Note that when operating with reduced heating power, the furnace may no longer be able to reach the maximum temperature specified on the type plate!
- 2) At setting "100", the furnace is operated with both heat outputs without reduction, for instance for an even temperature distribution when baking clay and ceramics.
- 3) At setting "0", output 1, for instance, the ceiling heater in fusing furnaces, is turned off. The furnace is heated only through the heater attached to output 2 (**A2**), e.g. the side and floor (see the furnace description). Note that when operating with reduced heating power, the furnace may no longer be able to reach the maximum temperature specified on the type plate!

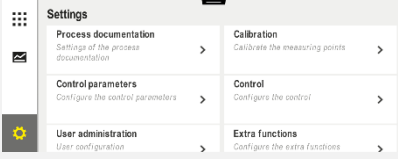
The settings can only be saved globally and not program-dependent.

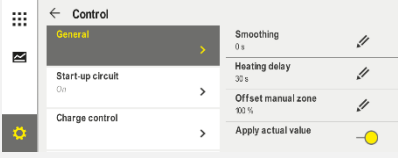
The following steps must be performed to set the function:

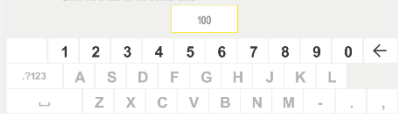
Set zone control			ADMINISTRATOR
Procedure	Operation	Display	Comments
Select [Settings]			This function can be parametrized only if the furnace is fitted with this function.
Select [Control]			
Select [General]			
Select [Offset Manual Zone] and set the offset			
Save			The changes are saved automatically when you exit the menu.



Caution

Consult the furnace directions to determine which output (A1) (A2) is responsible for which heating range. For furnaces with two heating circuits, Output 1 is always the upper and Output 2 is always the lower heating circuit

11.4.4 Integrating the actual value as setpoint for the program start

Application of the actual value is a useful function to shorten heating up times.

Normally, a program starts at the start temperature that was entered in the program. If the furnace is below the start temperature of the program, the specified ramp is still started and the furnace temperature is not applied.

When deciding the temperature at which it will start, the controller always bases its decision on which temperature is higher at that time. If the furnace temperature is higher, the furnace starts at the current furnace temperature; if the start temperature set in the program is higher, the program starts with the temperature that is set there.

This function is switched on when the controller is delivered.







With segment leaps actual value application is always activated. Therefore, segments may be skipped with segment leaps.

Example:

A program with a ramp from 20 °C to 1500 °C is started. The furnace still as a temperature of 240 °C. With activated take over actual value the furnace does not start at 20 °C but at 240 °C. The program can be substantially shortened.

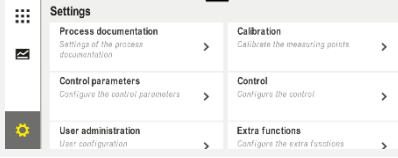
This function is also used for segment steps and program changes in a running heating program.

The following steps must be performed to activate or deactivate the automatic take over value:

Activate/deactivate automatic use of actual value			 ADMINISTRATOR
Procedure	Operation	Display	Comments
Select [Settings]			
Select [Control]			
Select [General]			
Select/deselect [Use Actual Value]			
Save			The changes are saved automatically when you exit the menu.

11.4.5 Controlled Cooling (option)

A furnace can be cooled in different ways. Cooling can be controlled or uncontrolled. Uncontrolled cooling takes place with the cooling fan set at a fixed speed. Controlled cooling also processes the temperature of the furnace and can set the correct cooling level at all times with variable speed control or flap settings without the intervention of the operator. Controlled cooling is necessary if the furnace is to use a linear cooling ramp that is faster than the natural cooling of the furnace. This is possible only within the physical limits of the furnace.

This controller is suitable for controlled cooling such as this. In a heating program, controlled cooling can be switched on and off for specific segments. In addition to activating a cooling function, the exhaust air flap must be opened permanently via an extra function or a switch setting. A description of the extra functions and the functionalities or other operating elements can be found in the separate switchgear description. Controlled and uncontrolled cooling cannot be activated at the same time. Using these functions is under the assumption that cooling is prepared in the furnace and activated in the controller ([SERVICE] menu). Otherwise, this option cannot be selected in program input. We recommend that cooling be activated only in a cooling ramp (decreasing setpoint).

The controlled cooling is realized with the help of a tolerance band around the setpoint (see the figure below). This tolerance band consists of 2 limit values that enclose a monitoring range.

This range is used as a hysteresis when switching between heating and cooling. The range should not be too large. A range of 2 - 3 °C has proved to be practical.

If the furnace temperature exceeds the upper band (1), cooling is activated (a fan for example) and all zones of the heating are switched off. If, during cooling, the furnace temperature falls below the lower band (3), the cooling is switched off.

If the furnace temperature is below the lower band (3), the heating is reactivated. If, during heating, the furnace temperature rises again above the upper band (1), the heating is switched off completely.

If there is a malfunction in the cooling thermocouple during active cooling, the system switches over to the thermocouple of the master zone.

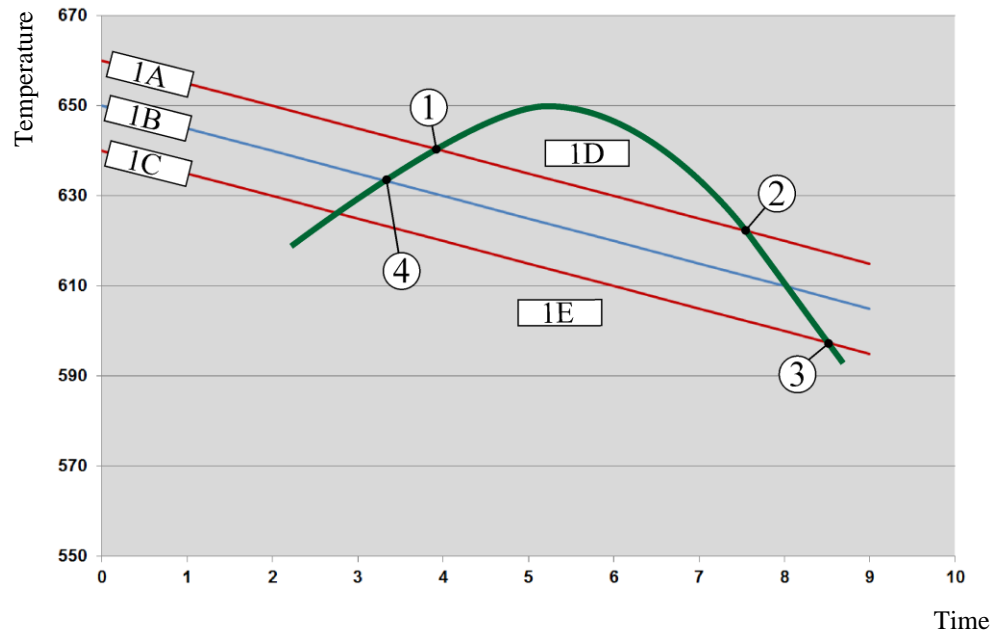

1A = upper band, 1B = setpoint, 1C = lower band, 1D = cooling, 1E = heating

Fig. 3: Switching between heating and cooling

Note

When the switchover from heating to controlled cooling is made, the I and D parts of the controller are also deleted.

To observe the control parameters of controlled cooling, please read “Information Menu -> Display PID Output”.

For controlled cooling, the thermocouple in the set master zone or a cooling thermocouple connected especially for controlled cooling is decisive (this depends on the furnace model). Documentation thermocouples or thermocouples from additional zones are not considered here. This applies also if charge control is active.

If controlled cooling is selected for a program segment, the zone thermocouple is switched to the cooling thermocouple for the complete segment. If no cooling thermocouple is connected, the thermocouple from the master zone is used for controlled cooling.





With active controlled cooling with a separate cooling thermocouple, the display in the main overview is switched to the temperature of the cooling thermocouple.

This does not apply if charge control is active. In this case, the temperature of the charge thermocouple is displayed.

In the process documentation, the cooling temperature (with or without a separate cooling thermocouple) is always recorded parallel to the control thermocouple and the cooling output.

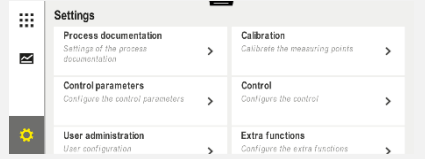
The controlled cooling can be parametrized in the [SETTINGS] menu.

This is done by performing the following steps:

Controlled cooling			ADMINISTRATOR
Procedure	Operation	Display	Comments
Select [Settings]			
Select [Control]			
Select [Controlled Cooling] and switch controlled cooling on or off			This parameter is visible only if controlled cooling is available. Activate controlled cooling here in order to select it in the program.
Set the limit value for heating			The value is entered in Kelvin .
Set the limit value for cooling			The value is entered in Kelvin .
Save			The changes are saved automatically when you exit the menu.

Behavior in Case of Error

If the cooling thermocouple is defective, the thermocouple in the master zone is used. The temperature in the zone with the defective thermocouple is shown with "-- °C".

A defect is also displayed if no controlled cooling is selected.

11.4.6 Start-Up Circuit (Output Limit)



A temperature control always reacts to a deviation between setpoint and the actual temperature value in the furnace. If this difference is large, the controller attempts to reduce this difference by means of greater heating power. This can lead to damage to the charge or the furnace.

This can have, for example, the following reasons:

- Use a thermocouple with major imprecision in the lower temperature range (for example type B)
- Use of pyrometers that in the lower temperature range do not deliver a measurement value
- Use of thermocouples with heavy-duty protective tubes and, hence, longer delay time

In order to limit the power peaks of the heating system in the lower temperature range in these cases, you are provided with the function "Start-Up Circuit/Output Limit". With this function you can limit the controller output for the heating to a specified temperature [LIMIT TEMPERATURE] to a specific output [MAX POWER]. Independent of the set setpoint, the furnace does not heat up with more power than in the startup circuit.

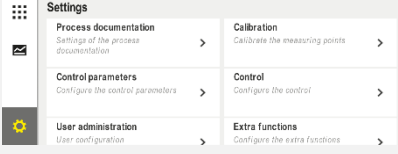
The following steps must be performed to set the startup circuit/power limit:

Set the start-up circuit/power limiter			ADMINISTRATOR
Procedure	Operation	Display	Comments
Select [Settings]			
Select [Control]			
Select [Start-Up Circuit] and switch the start-up circuit on or off			
Enter limit temperature			
Specify maximum power in [%]			
Save			The changes are saved automatically when you exit the menu.

The startup circuit analyzes the following thermocouples:

- For a single-zone control: The control thermocouple is monitored
- For a single-zone control with charge control: The control thermocouple is monitored
- For a multi-zone control: All the zones are monitored individually. If a zone is below the limit temperature, the output power of the corresponding zone is limited correspondingly.
- For a multi-zone control with charge control: In this combination, the startup circuit behaves like a multi-zone controller.

11.4.7 Self Optimization

The behavior of controllers is determined by control parameters. The control parameters are optimized to a specific process behavior. To allow furnace operation to be as rapid as possible other parameters are used than those for an operation that is as precise as possible. To simplify this optimization, this controller offers the option of an automatic optimization, self-optimization. This does not replace the manual optimization and can only be used for single-zone furnaces, not multi-zone furnaces.

The control parameters of the controller have already been set at the factory for an optimum control of the furnace. If the control behavior must be adapted for your process, you can improve the control behavior by means of a self-optimization.

The self-optimization takes place in a specific sequence and, in addition, can only be performed, each time, for one temperature [OPT TEMPERATURE]. The optimization of several temperatures can only be performed one after another.

Start the self-optimization only when the furnace is cooled down ($T < 60\text{ °C}$), since otherwise false parameters are calculated for the control section. First enter the optimization temperature. The self-optimization is performed in each case at approx. 75 % of the set

value to prevent a destruction of the furnace, for example for the optimization of the maximum temperature.

For some models, the self-optimization can take longer than 3 hours depending on the type of furnace and temperature range. The control behavior can be worsened by a self-optimization in other temperature ranges! Nabertherm assumes no liability for damages that are caused by manual or automatic change in the control parameters.





For this reason, check the control quality after autotune by operating the furnace without charge.



Note

Execute the autotune, if necessary, for several temperature ranges. Autotunes in lower temperature ranges (< 500 °C/932 °F) can return extreme values depending on the calculation procedure. Correct these values, as necessary, by a manual optimization. Always check the returned by performing a test run.

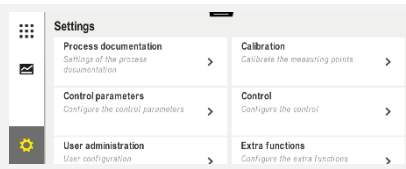

The following steps must be performed to launch a self-optimization:

Start auto-tune			 ADMINISTRATOR
Procedure	Operation	Display	Comments
Select [Settings]			
Select [Control]			
Select [Auto-Tune]			
Enter the optimization temperature			
Start auto-tune			When this is confirmed, the controller starts to heat the furnace to the set temperature.

If self-optimization was started, the controller heats to 75 % of the optimization temperature at full power. The heating process is then stopped and restarted at 100 % power. This procedure is carried out twice. Self-optimization is then finished.

After the autotune has been completed, the controller ends the heating and enters the calculated control parameters but not yet into the corresponding base point of the control parameters.

To save the calculated parameters, open the autotune menu again and check the parameters. Then you can select the base point in the same menu in which you want to copy the parameters.

Auto-tune: Check and save parameters			ADMINISTRATOR
Procedure	Operation	Display	Comments
Wait until optimization is finished			
View and check the determined control parameters xp, Tn, Tv	 		

11.4.8 Charge Control

The cascade, charge or melting bath control system is a combination of two control circuits which permits the temperature measured directly at the product being treated to be adjusted very precisely and rapidly dependent on the furnace chamber heating. When the charge control is turned on (cascade control) the temperature is measured by an additional thermocouple directly at the charge, for example in an annealing box, and controlled in relation to the furnace temperature.

Operation with Charge Control (cascade control)

When the charge controller (cascade) is turned on, both the charge temperature and the furnace chamber temperature are measured. A setpoint offset is generated for the furnace chamber, corresponding to the amount of the control deviation. This achieves a substantially quicker and more precise temperature control at the charge.

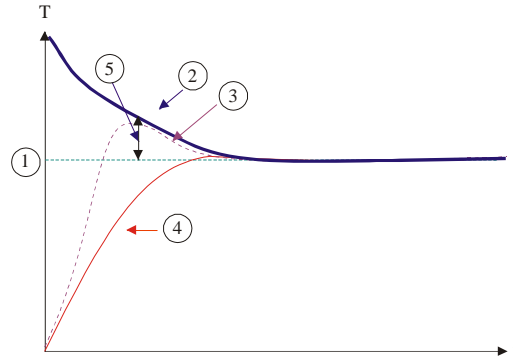

- ❶ Setpoint charge
- ❷ Setpoint furnace chamber
- ❸ Actual value furnace chamber
- ❹ Actual value charge/tank
- ❺ Setpoint offset

Operation with Charge Control (cascade control)

When the charge control (cascade) is switched off only the furnace chamber temperature is measured and corrected. Since the charge temperature in this context has no influence on the regulation, it approaches the program setpoint more slowly.

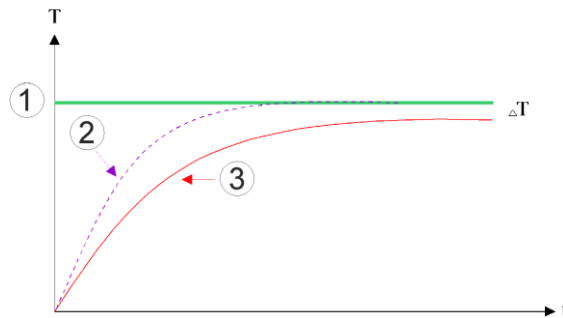

- ① Setpoint furnace
- ② Actual value furnace
- ③ Actual value charge/bath

As explained in the previous paragraphs, the charge controller influences the furnace chamber controller to compensate the deviation between the thermocouple at the heating elements and the thermocouple at the charge (e.g., in the middle of the furnace). This compensation must be limited so that the furnace does not begin to vibrate.

The following parameter can be adapted for this purpose:

Maximum Negative Output

The maximum negative offset that is transferred from the charge controller to the heating controller/zone controller. Hence, the setpoint of the heating zone cannot become smaller than:

- Heating setpoint = program setpoint – maximum negative offset.

Maximum Positive Output

The maximum positive offset that is transferred from the charge controller to the heating controller/zone controller. Hence, the setpoint of the heating zone cannot become greater than:

- Heating setpoint = program setpoint + maximum positive offset.

No I-Portion in Ramps

In ramps it is possible that the I value (integral portion of the output) of the charge controller slowly builds up a lasting control deviation. For the transition into the dwell time this cannot fall rapidly enough and the result may be an overshoot.





To avoid this effect, a build-up of the I-portion of the charge controllers in ramps can be deactivated.

Example:

If for the charge setpoint 500 °C is pre-set, the furnace chamber can, for an optimum control, accept a setpoint of 500 °C + 100 °C, i.e. 600 °C. The result is that the furnace chamber can heat up the charge very rapidly.

Depending on the process and the charge, it may be necessary to change the offset values. For example, a too sluggish control can be accelerated by a higher offset, or a too rapid control can be slowed down. However, the offset should only be changed after consultation with Nabertherm since the control behavior is largely determined by the control parameters and not by the trim.

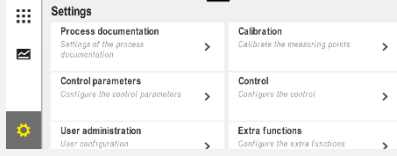
The following steps must be performed to set the charge control:

Charge control			 ADMINISTRATOR
Procedure	Operation	Display	Comments
Select [Settings]			
Select [Control]			
Select [Charge Control]			
Set the maximum negative value	The value is entered in Kelvin		Range in which charge control may influence the heating zones.
Set the maximum positive value	The value is entered in Kelvin		Range in which charge control may influence the heating zones.
Switch the I part of the PID controller in ramps on or off with the function [I-BLOCK FOR RAMPS]			Note: In some cases, this setting results in the program not leaping to the next segment. Then select holdback mode [Manual]
Choose whether a negative value for charge control is permissible, even outside the cooling ramps. Parameter text: [BLOCK LOWERING]			Default setting: [YES] Select [NO] only if you are clear about the consequences on the process. Observe the information below.
Changes do not have to be saved			They are saved immediately after entry.

Additional Instructions:

- When the charge control is active, the large temperature display of the main overview is switched to the charge thermocouple.
- The error analyses that are part of the charge control (for example, a pulled charge thermocouple), are only activated if the charge control is activated in a running program. If the charge thermocouple has an error, a switchover is made to the master zone thermocouple and an error message is outputted. A program interrupt does not take place.
- The switchover between the control parameters, for example from Support point 1 to Support point 2 conforms with the program setpoint, not with the actual temperature value in the furnace.

- With activated charge control, it is recommended to use the holdback type “Auto” in the program. If extended holdback is used, the offsets that are generated can result in undesired warnings.

Limiting the Offset of the Charge Controller [BLOCK LOWERING]:

Charge control does not directly affect the heating; it influences the heating controller indirectly via an offset on the program setpoint. This offset (output) is simply added to (positive offset) or subtracted from (negative offset) the setpoint. A negative offset is usually permissible only with decreasing (negative) ramps, as otherwise fluctuations would occur.



Certain furnace series (such as tube furnaces) need the option that the negative offset is also active during hold times or heating ramps. Otherwise, it could happen that the program does not go to the next segment.

This release can be granted via the parameter [BLOCK LOWERING] = [NO] in the charge control settings. This adaption should only be performed if it is necessary for the process.

11.4.9 Setpoint Offsets for Zones

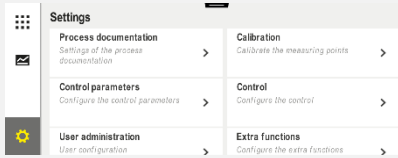

With multi-zone furnaces it may be necessary to give the zones different setpoints. Normally, all the furnace zones work with the setpoint that is generated from the heating program. For example, if a zone does not have 600 °C has a setpoint as the other zones do, but instead only 590 °C, this is possible using the "Zone Offset Set Value".

The following steps must be performed to enter setpoint offsets for one or several zones:

Enter setpoint offsets for one of more zones			ADMINISTRATOR
Procedure	Operation	Display	Comments
Select [Settings]			
Select [Control]			
Select ZONE OFFSET SETPOINT			
Select the zones and their offset			The value is entered in Kelvin.
Changes do not have to be saved			They are saved immediately after entry.

11.4.10 Holdback

To set the extended holdback, the zones to be monitored for the transition of a temperature ramp can be defined in a hold time. Depending on how the furnace is equipped, you can select a check of control zones 1-3, documentation thermocouples 1-3, cooling and charge. To select the thermocouples, take the following steps:

Select the thermocouples to be monitored for extended holdback			 ADMINISTRATOR
Procedure	Operation	Display	Comments
Select [Settings]			
Select [Control]			
Select [Extended Holdback]			
Select or deselect the thermocouple			The selected thermocouples are used for extended holdback.
Changes do not have to be saved			They are saved immediately after entry.

Caution!

If charge control is activated, it is not recommended that you select other thermocouples for extended holdback.

11.5 User Administration

The user administration allows certain operating functions to be protected by a password. This means that an operator with basic rights cannot change any parameters.

For this purpose 4 user levels are available:

User	Description	Passwords (default setting)
OPERATOR	Operator	00001 ¹
SUPERVISOR	Person in charge of process	00002 ¹
ADMINISTRATOR	Person with responsibility for the system	00003 ¹
SERVICE	Only for Nabertherm Service	*****
Reset passwords	Available on request	*****

¹ For security reasons, we recommend that passwords be changed when the furnace is started up for the first time. To do this, you must be in the user level where you can change the password for the respective user level (see “Change User Administration According to Requirements”).

The rights of the individual users are assigned as follows:

User	Assignment of rights	
OPERATOR	View overviews	
	Operate extra functions manually	
	Unlock controller	
	Load, view, start, hold and stop the program	
	Select language	
	Initiate export files	
	Select user, reset all passwords and change the password for the operator	
	Read out the information menu	
	SUPERVISOR	<i>All rights of the [Operator], plus</i>
		Segment jump
Change current program		
Enter, delete, and copy programs		
Switch on controller lock		
Upload process documentation		
Set date and time		
Change the password for the supervisor and log out the user		
ADMINISTRATOR	Switch on operating lock	
	<i>All rights of the [Supervisor], plus</i>	
	Enable/disable interfaces (USB/Ethernet)	
	Calibration	
	Controller smoothing	
	Set delay after door is closed	
	Set control parameters	
	Set manual zone control	
	Enable/disable actual value application	
	Set controlled cooling	
	Set start-up circuit	
	Carry out self-optimization	
Set zone offsets		
Set charge control		

User	Assignment of rights
	Change extra functions
	Change alarm functions
	Change gradient monitoring
	System: Temperature unit, date and time format
	Set interfaces
	Set power failure behavior (only operating mode)
	Import parameters and programs via USB flash drive
	Log on modules
	Change the administrator's password and reset passwords
	Define standard users
	Define logout time
	Reset passwords of other users individually
	Define who may change the active program
	Define who may create the app TAN





User Registration



Note – Quick log in for users

To log in as a user quickly, go to the status bar. To do this, pull down the top tab. Press the user icon. The user selection view opens. Select the respective user and then enter the password.

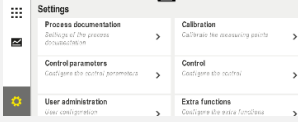
You can log-on a user without using the quick selection by carrying out the following steps:

Log in a user (user level)			 OPERATOR/SUPERVISOR/ ADMINISTRATOR
Procedure	Operation	Display	Comments
Select [Settings]			
Select [User Administration]			
Select user			
Enter password	OPERATOR SUPERVISOR ADMINISTRATOR		If you enter an incorrect password, a warning will be issued [PASSWORD INCORRECT].

Changes do not have to be saved

They are saved immediately after entry.

Adopting User Administration by Needs

To adapt the user administration to their needs, please perform the steps described below. Here, the time can be set after which the user is automatically logged off again. Equally, the user level can be set to which the controller returns after the log-off [STANDARD USER]. That means, which functions are available without having to register.

Change user administration according to requirements			 ADMINISTRATOR
Procedure	Operation	Display	Comments
Select [Settings]			
Select [User Administration] → [User Level]		<ul style="list-style-type: none"> - Display current user - Log out current user (standard user is activated) - Select user 	
If required, change the password of a user. Select the user and enter the new password twice.		Only users themselves can change their passwords (Operator, Supervisor, Administrator).	Note down the changed passwords
Select [User Administration] → [User Rights]			
If necessary, change the [Logoff Time]			
Select [Standard user]		The standard user is the user that is active automatically when the controller is switched on.	
Activate [OPERATION LOCK]: Select this parameter to activate a basic operation lock for the operator			See “Continuous Controller Lock”.
[Change active program]		The user set here is allowed to create and change programs.	
If necessary, reset the passwords of all users with [PASSW RESET CMPL]			Request the necessary password from Nabertherm Service
Changes do not have to be saved			They are saved immediately after entry.

Rights of the individual users for rights management

Function	Operator	Supervisor	Administrator
Change User	x	x	x
Reset all passwords	x	x	x
Switch on operating lock	-	x	x
Log out current user	-	x	x
Log out standard user	-	-	x
Change logout time	-	-	x
Reset operator's password	-	-	x
Reset supervisor's password	-	-	
Reset administrator's password	-	-	x
Change operator's password	x	-	-
Change supervisor's password	-	x	-
Change administrator's password	-	-	x
Define which users may change the active program	-	-	x
Define which users may view the app TAN	-	-	x

11.6 Controller Lock and Operation Lock

11.7 Permanent Lock (Operation Lock)

To prevent operation of the controller permanently, use the function [Operation Lock]. This prevents any access to the controller, even if no program has been started.

The supervisor or administrator can activate the operation lock in user administration with the parameter [Operation Lock].

The operation lock is effective when the user is logged off automatically or manually. The operation lock is also activated when the controller is switched on.

A password prompt is displayed for every operation step. Enter the password for the required user.

Activate operation lock			ADMINISTRATOR
Procedure	Operation	Display	Comments
Select [Settings]			
Select [User Administration]			
Select [User Rights]			
Select [Operation Lock]	Select yes/no		If you select [yes], the controller is locked after you switch it off and on again and also after you log off.
The controller lock is shown by an icon in the status bar			
Unlock operation	Enter the required user name and password		

11.7.1 Locking the Controller While a Program is Running





If you want to prevent a program being interrupted deliberately or inadvertently while it is running, this can be done by locking the controller. The lock prevents input on the controller.

Operation can be released only when a user logs on (operator, supervisor, administrator) with his/her password.

To lock the controller, take the following steps:

Lock controller			OPERATOR
Procedure	Operation	Display	Comments
Select [Furnace]			A heating program must have been started.
In the context menu, select [Lock Controller]			If the controller is locked, the selection “unlock” is available, which unlocks the controller when the administrator password is entered.
The controller lock is shown by an icon in the status bar			

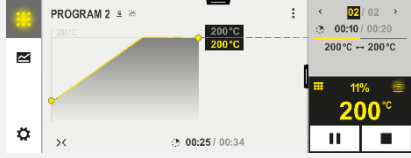
To unlock the controller, take the following steps:

Unlock controller			 SUPERVISOR
Procedure	Operation	Display	Comments
Select [Furnace]			
Select the context menu [Unlock controller]			If the controller is locked, the selection [Unlock controller] is available, which unlocks the controller when the administrator password is entered.
Select the standard user and enter the password			

11.8 Configuring the Extra Functions

Besides heating, many furnaces support additional functions such as exhaust-air flaps, fans, solenoid valves, optical and acoustic signal (see, as necessary, addition instructions for the extra functions). For this purpose, each segment offers an opportunity to enter values. How many extra functions are available depends on the furnace design.





With this controller, in the basic configuration, optionally, up to 2, with additional modules, up to 6 extra functions, depending on the program, can be switched on or off in the segments.

Extra Functions Are for Example

- Activating a fresh-air fan
- Activating an exhaust air flap
- Activating a signal lamp

If you want to deactivate or rename individual functions, perform the following steps.

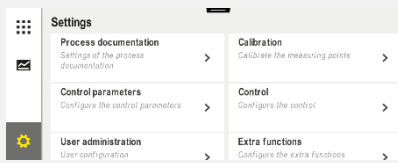



11.9 Hide or Rename Extra Functions

Deactivate or rename extra functions			 ADMINISTRATOR
Procedure	Operation	Display	Comments
Select [Settings]			
Select [Extra Functions]			
Select extra function	Extra function 1-2 (P5xx = 1-6)		

Switch extra function on or off			
Select a pre-defined name with icon for the extra function			
If required, edit the selected name			If you change the name of the extra function, the icon is not changed.
Changes do not have to be saved			They are saved immediately after entry.

11.9.1 Manually Operating Extra Functions During a Running Heating Program

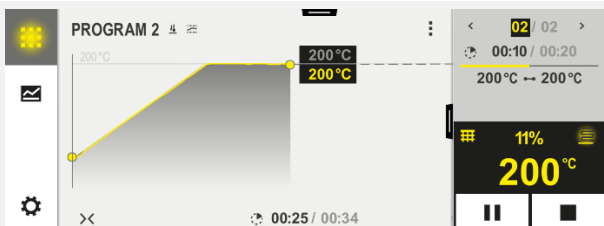
The following steps must be performed if you want extra functions to be manually switched on during a running heating program.

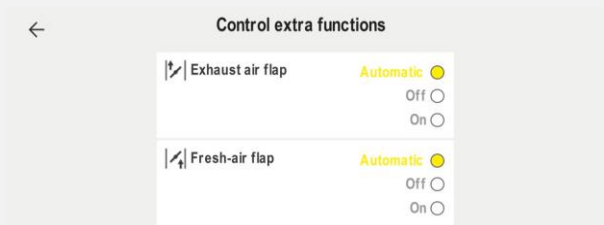



Use extra functions during a current heating program			 OPERATOR
Procedure	Operation	Display	Comments
Select [Furnace]			A heating program must have been started.
Select [Control Extra Functions] in the context menu			A list of available extra functions is displayed
If required, change the status of the extra function	Choose from the selection field next to the statuses [Auto]/[Off]/[On]	The selection field changes color	
<p>The extra function has now been changed manually. There are three statuses available for extra functions</p> <p>AUTO The extra function is controlled only by the extra functions defined in the heating program</p> <p>OFF The extra function is switched off regardless of the heating program</p> <p>ON The extra function is switched on regardless of the heating program</p>			

**Caution**

Please check what the effects of a manual setting and resetting of an extra function will have on your charge before you do it. Weigh the advantage and the damage carefully before manually intervening.

11.9.2 Manually Operating Extra Functions According a Heating Program

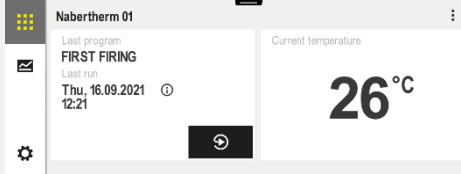
The following steps must be performed if you do not want extra functions to be manually operated during a running heating program.

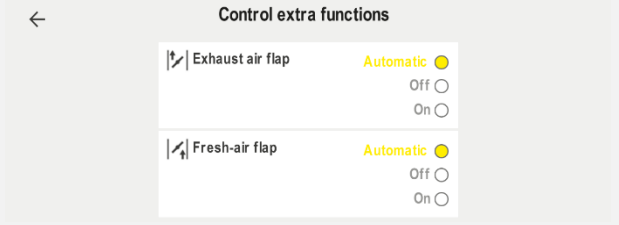
Use extra functions when no heating program is running			 OPERATOR
Procedure	Operation	Display	Comments
Select [Furnace]			
Select [Control Extra Functions] in the context menu			
If required, change the status of the extra function	Choose from the selection field next to the statuses [Auto/Off/On]	The selection field changes color	
	<p>The extra function has now been changed manually. There are three statuses available for extra functions</p> <p>AUTO The extra function is controlled only by the extra functions defined in the heating program</p> <p>OFF The extra function is switched off regardless of the heating program</p> <p>ON The extra function is switched on regardless of the heating program</p>		
Reset extra functions	<p>Extra functions that have been set manually are reset either with [AUTO] or [OFF]. Extra functions that have been set manually are also reset at:</p> <ul style="list-style-type: none"> • Program start • Segment change • Program end 		

**Caution**

Please check what the effects of a manual setting and resetting of an extra function will have on your charge before you do it. Weigh the advantage and the damage carefully before manually intervening.

11.10 Alarm Functions

11.10.1 Alarms (1 and 6)





This controller has 6 freely configurable alarms. An alarm triggers a response in a certain situation. An alarm can be changed flexibly.

Parameters of the alarms:

Parameters	
[SOURCE]	<i>Cause for the alarm:</i>
	[BAND ALARM]: A tolerance band is exceeded or undershot. Evaluation is relative to the current setpoint.
	[MAX]: A temperature limit is exceeded. The evaluation relates to the absolute actual temperature
	[MIN]: A temperature limit is undershot. The evaluation relates to the absolute actual temperature
	[PROGRAM END]: The end of the program is reached
	[A1]-[A6]: These two signal sources are linked with inputs in the module configuration. Only Nabertherm can make this link.
	[A1 inverted]-[A6 inverted]: These two signal sources are linked with inputs in the module configuration and are then inverted. Only Nabertherm can make this link.
[RANGE]	<i>Range in which monitoring is to take place</i>
	[HOLD TIME]: A hold time has the same start and target temperatures
	[RAMP]: The start and target temperatures differ in a ramp
	[PROGRAM]: For hold times and ramps; in other words, during the complete program
	[ALWAYS]: Regardless whether a program is active or not.
[LIMITS]	<i>Depending on the source, additional limit values are queried</i>
	[LIMIT MIN]: With source = [BAND ALARM]: Lower limit relative to the setpoint. [0] deactivates monitoring With source = Min/Max: Absolute lower limit temperature
	[LIMIT MAX]: With source = [BAND ALARM]: Upper limit relative to the setpoint. [0] deactivates monitoring With source = Min/Max: Absolute upper limit temperature

Parameters	
[DELAY]	<i>Time that the alarm is to be delayed in seconds</i>
[TYPE]	<i>Definition whether the alarm reaction has to be acknowledged before it is reset. It is also defined here whether a warning is to be output.</i>
	[GOING]. If the alarm is no longer present, the reaction is automatically reset. No warning is displayed.
	[GOING+REPORT]: If the alarm is no longer present, the reaction is automatically reset and must be acknowledged by the operator. A warning is displayed
	[SAVE+REPORT]: If the alarm is no longer present, the reaction is not automatically reset and must be acknowledged by the operator. A warning is displayed
[RESPONSE]	<i>Response to the alarm. If the alarm condition is fulfilled, the following reactions are possible:</i>
	[RELAY ONLY]: A relay is set. This relay must be configured in the module configuration
	[ACOUSTIC ALARM]: An acoustic alarm is output. The acoustic alarm has additional parameters
	[PROGRAM STOP]: The current program is interrupted
	[HOLD]: The current program is paused
	[HOLD HEATING OFF]: The current program is paused and the heating is switched off. The safety relay is also deenergized.

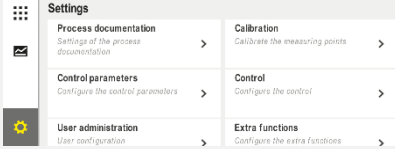
Alarms can be configured as follows:

Configure alarms			 ADMINISTRATOR
Procedure	Operation	Display	Comments
Select [Settings]			
Select [Alarm Functions]		In the “Settings” menu, scroll down to [Alarm Functions]	
Select an alarm	Alarm 1-6		
Select [SOURCE] and set the required mode			
Select [RANGE] and select the required range			

Configure alarms			 ADMINISTRATOR
Procedure	Operation	Display	Comments
Select [LIMIT MAX] and enter the required value			The visibility of the parameter depends on the selected source
Select [LIMIT MIN] and enter the required value			The visibility of the parameter depends on the selected source
Select [DELAY] and enter the required value			Do not set the time too short so that fluctuations in the process do not cause false alarms.
Select [TYPE] and enter the required value			
Select [REACTION] and enter the required value			

Validity of the Band Alarm and the Min/Max Analysis:

Below you can see a table showing which thermocouples are monitored by a band alarm.

Furnace has 1 zone	The control thermocouple is monitored
Furnace has 1 zone and active charge control	Charge thermocouple is monitored
Furnace has several zones	Master control thermocouple is monitored
Furnace has several zones and active charge control	Charge thermocouple is monitored
Segment with controlled cooling and separate cooling thermocouple	When cooling is enabled, the separate cooling thermocouple is monitored
Segment with controlled cooling without separate cooling thermocouple	When cooling is enabled, the master control thermocouple is monitored





An optional documentation thermocouple is not included.

11.10.2 Acoustic Alarm (Option)

The acoustic alarm is one of the possible “reactions” in alarm configuration. The parameters of the acoustic alarm allow the operator to set certain additional properties. Regardless of the configuration, the output where the acoustic alarm is connected can be output constantly, at intervals or with time limits. The acoustic alarm is acknowledged by acknowledging the error message.

Parameters	
[CONSTANT]	In case of alarm, a continuous alarm signal is generated.
[LIMITED]	The alarm signal is interrupted after a preset time and, then, remains turned off.
[INTERVAL]	The alarm signal is turned on for a preset time and then turned off for this preset time. This procedure repeats.

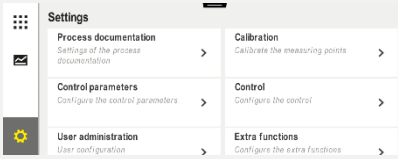
The acoustic alarm can be set as follows:

Configure alarms			 ADMINISTRATOR
Procedure	Operation	Display	Comments
Select [Settings]			
Select [Alarm Functions]			
Select [ACOUSTIC ALARM]			
Select [MODE] and set the required mode			See description above
Set the duration			The effect of this duration depends on the selected mode (see above)
Changes do not have to be saved.			

11.10.3 Gradient monitoring

Gradient monitoring monitors the rate at which a furnace heats up. If the furnace heats up faster than set in the limit value (gradient), the program is interrupted.

What is decisive for a reliable analysis of the gradients is the time interval in which the gradient is repeatedly recalculated (sample interval). If it is too short, the gradient alarm is sensitive to fluctuations of the control or the furnace and probably will be triggered too soon. If the sampling interval selected is too long this may also have an impact on the charge or the furnace. This is why the right sampling interval must be calculated by trial runs.

In addition to the sampling interval, a delay of the alarm can be activated. For example, a delay of "3" means that only after 3 measurement cycles have been recognized as having excessive gradients does a reaction take place.





In order to avoid faulty measurements in the lower temperature range, a lower limit temperature can be selected for the analysis.

In the case of multi-zone furnaces and furnaces with charge control, always only the master zone (guide zone) is analyzed.

After a gradient alarm, the first sample interval that does not return a gradient exceedance restarts the heating program. The furnace runs again.

The warning for the gradient alarm can be deleted by switching the controller off and on again.

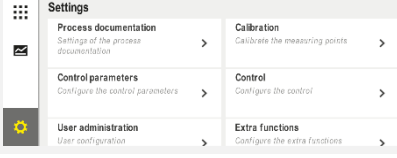
The following steps must be performed to set the gradient monitoring:

Set gradient monitoring			 ADMINISTRATOR
Procedure	Operation	Display	Comments
Select [Settings]			
Select [Alarm Functions]			
Select the [GRADIENT MONITORING] menu			
Switch monitoring on or off			
Set the minimum temperature for monitoring		e.g., 200°C	
Set the permitted gradient (temperature rise)		e.g., 300°C/h	
Checking interval (length of the measurement cycle)		e.g., 60 seconds	
Set the alarm delay			The delay defines the number of measurement cycles that take place before the alarm is activated.
Changes do not have to be saved.			



Caution

This function contributes to protecting the charge and the furnace. A use for the avoidance of dangerous conditions is not permissible.

11.10.4 Examples of Alarm Configuration

Below is some help to parameterize frequently occurring alarms. These examples are for illustration purposes only. The parameters may have to be adjusted to the specific application:

To adjust the alarms, remember to log on as [ADMINISTRATOR].

Example: External error

An external error, e.g. a temperature switch signals an over-temperature by closing a contact. This should result in a program interrupt.

Function	Source	Range	Limits	Delay	Type ¹	Reaction
External fault	A1	Always	-	2s	Save + Report	[PROGRAM INTERRUPT]:

Explanation: The source of the alarm is an input that was linked to [A1], which is evaluated [always], that is, during ramps and hold times. After a delay of [2 seconds], a reaction that must be acknowledged S = [Save], namely [Program interrupt], is triggered with a clear text message M = [Report].

The output configuration of an acoustic alarm must be set at the factory.

Examples: Cooling water monitoring

When the cooling water flow of a furnace is monitored. After a flow switch is triggered, the program will be held up and the heating turned off. An acoustic alarm will signal an error.

Function	Source	Range	Limits	Delay	Type ¹	Reaction
Cooling water monitoring	A1	Always	-	2s	Save + Report	[HOLD-HEATING OFF]
Acoustic alarm	A1	Always	-	2s	Save + Report	[ACOUSTIC ALARM]

Examples: Monitoring of an external vacuuming

For certain processes it is important that during the heating program an external venting is switched on. This should be monitored by the controller and the program interrupted, if necessary, if the venting has not been switched on. In addition, an acoustic alarm should signal the error.

Function	Source	Range	Limits	Delay	Type ¹	Reaction
External extraction	A1	Always	-	120s	Save + Report	[PROGRAM INTERRUPT]:
Acoustic alarm	A1	Always	-	120s	Save + Report	[ACOUSTIC ALARM]

Explanation: The source of the alarm is an input that was linked to [A1], which is evaluated [always], that is, during ramps and hold times. After a delay of [120 seconds], a reaction that must be acknowledged S = [Save], namely [Program interrupt], is triggered with a clear text message M = [Report].

The output configuration of an acoustic alarm must be set at the factory.

Example: Relative Over-Temperature Monitoring

A dwell time should be monitored. Here, the program setpoint should not be exceeded by more than 5 °C.

Function	Source	Range	Limits	Delay	Type ¹	Reaction
Relative Temperature Monitoring	Band	Hold time	Max = 5° Min = -3000°	60s	Transient + Report	[HOLD-HEATING OFF]

Explanation: The source of the alarm is band monitoring [Band], which is [always] evaluated, that is, during ramps and hold times. After a delay of [60 seconds], a reaction that must be acknowledged [Transient], namely [Program interrupt], is triggered with a clear text message M = [Report].

11.11 Network Failure Behavior Settings

In case of a power outage, no heater power remains. Hence, any power outage has an impact on the product in the furnace.

The behavior of the controller during a grid power outage has been preset at Nabertherm. But you can always change this behavior to suit your own needs.

There are 4 modes available:

Mode	Parameter
Mode 1	[CANCEL]: If there is a power outage, the program is canceled.
Mode 2	[DELTA T] When the power returns, the program continues if the furnace has not cooled too much [$<50\text{ °C}/90\text{ °F}$]. Otherwise the program is canceled. The program is always canceled below a limit temperature [T min = $80\text{ °C}/144\text{ °F}$].
Mode 3	[TIME] (pre-selection) When the power returns, the program continues if the power was not out for longer than the set time [max. power outage time 2 minutes]. Otherwise the program is canceled.
Mode 4	[CONTINUE] When the power returns, the program always continues.







Caution

After a power outage the program, i.e. the remaining run time of the dwell time, is continued at the same rate.

Power outages $< 5\text{ s}$ are always continued.

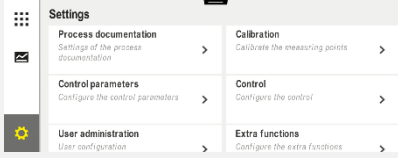
The behavior after power outage can be set as follows:

Set power outage			 ADMINISTRATOR
Procedure	Operation	Display	Comments
Select [Settings]			
Select [Power Outage]			
If required, set the mode for power outage behavior as described in the table above			

Set power outage			ADMINISTRATOR
Procedure	Operation	Display	Comments
Changes do not have to be saved.			

11.12 System Settings



11.12.1 Setting Date and Time

This controller needs a real-time clock for saving process data and the setting of a starting time. This is buffered with a battery in the operating housing.

There is no automatic reset from daily saving to standard time. The time must be reset manually.

The time may only be reset if no program is active to avoid irregularities during the recording of process data.

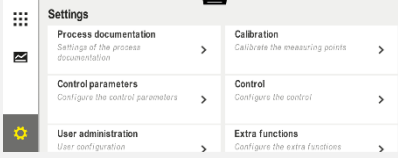
The following steps must be performed to set the time and the date:

Set date and time			SUPERVISOR
Procedure	Operation	Display	Comments
Select [Settings]			
Select [System]			
Select [Date and Time]			
Set the time and date			
Changes do not have to be saved.			



Caution

The operating life of the battery is approx. 3 years. When the battery is replaced the time setting is lost. Battery type: see "Technical Data".





11.12.2 Setting the Date and Time Formats

The date can be entered/outputted in two formats:

- DD.MM.YYYY - Example: **28.11.2021**
- MM-DD-YYYY - example **11.28.2021**

The time can be entered either in a **12**-hour or a **24**-hour format.

The following steps must be performed to set these formats:



Set the date and time format (12h/24h)			ADMINISTRATOR
Procedure	Operation	Display	Comments
Select [Settings]			
Select [System]			
Select [Date Format] and/or [Time Format]		Date format 1: DD-MM-YYYY Date format 2: MM-DD-YYYY Time format: Choose between 12 and 24 h display	
Changes do not have to be saved.			

11.12.3 Language Setting

The available languages can be selected on the display/screen. When you are making your selection, a list of the available languages is displayed.



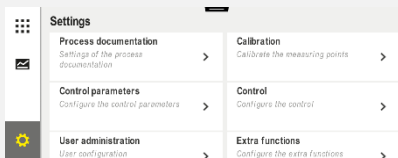



The language is selected via the wizard at initial set-up.

You can set the language without using the quick selection by carrying out the following steps:

Set language			OPERATOR
Procedure	Operation	Display	Comments
Select [Settings]			
Select [System], then Language			
Select the language			
Changes do not have to be saved.			

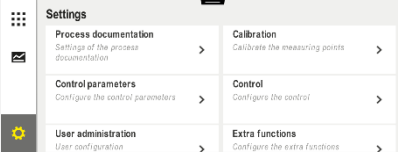
11.12.4 Setting Display Brightness

With this controller, the display brightness can be adjusted continuously in percentages.

Setting display brightness			 OPERATOR
Procedure	Operation	Display	Comments
Select [Settings]			
Select [System], then Language			
Select [Display Brightness]			
Enter the brightness value as a percentage.			
Save the changes.			





11.12.5 Change Temperature Unit (°C/°F)

This controller can display two temperature units:

- °C (Centigrade, default setting)
- °F (Fahrenheit)

After a reset, all the inputs and outputs of temperature values are displayed in the corresponding unit, and/or entered. Only the inputs in the service area are not reset.

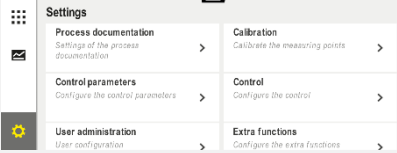
The following steps must be performed to change the temperature unit:

Change the temperature unit (°C/°F)			 ADMINISTRATOR
Procedure	Operation	Display	Comments
Select [Settings]			
Select [SYSTEM] and then [TEMPERATURE UNIT]			
Select temperature unit	°C or °F		
Switch on/off decimal place display			
Changes do not have to be saved.			

11.12.6 Setting the Interface

There are 2 ways to record process data:

Data recording using the USB interface	
	Onto a USB stick via the USB interface
Interface	USB 2.0
Memory capacity	up to 2 TB
File system	FAT32

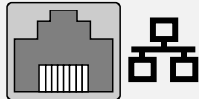
Data recording via Ethernet interface	
	Recording with the VCD process data software via an optional Ethernet interface. Files cannot be stored in a network folder or on an external hard drive.

The Ethernet interface, in contrast to the USB interface, requires additional settings to be connected to a network.

These are:

Required settings if an Ethernet interface is used	Explanation
DHCP	Mode for address assignment
IP address	Address of the Ethernet interface. Network subscribers may not use the same IP address
Subnet mask	Mask for describing the address space
Gateway	Address of the active node
DNS server	Server address for name resolution
Host name	Default setting: [serial number] 8 characters must be entered. Entry must be in Latin characters
Communication port	Port 2905







Caution

Consult your network administrator about the settings.

The use of this interface is not possible in connection with IPv6. Connect the controller to an existing network without knowledge about this network can lead to malfunctions in the network.

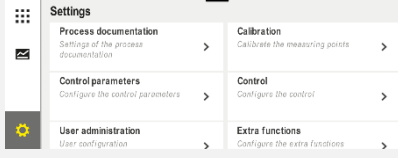
The following steps must be performed to set these parameters:

Set the data interface (USB/Ethernet)			 ADMINISTRATOR
Procedure	Operation	Display	Comments
Select [Settings]			
Select [SYSTEM] and then [INTERFACES]			
Select [DHCP] and the address assignment mode			DHCP = Yes: The address of the controller is provided via the customer's DHCP server DHCP = No: The address is entered manually
Select [IP ADDRESS] and enter the IP address			If you are unsure, ask your IT department about network integration.
Select [SUBNET MASK] and enter it			If you are unsure, ask your IT department about network integration.
Select [GATEWAY] and enter it			If you are unsure, ask your IT department about network integration.
Select [DNS SERVER] and enter it			If you are unsure, ask your IT department about network integration.
Enter [HOST NAME]			If you are unsure, ask your IT department about the host name. 8 characters must always be entered. This name is also used for the data folder on a USB flash drive. Note! Names can be entered only with Latin letters.
Changes do not have to be saved.			

Sample Configuration with DHCP Server (only available with router or in larger networks)

DHCP	Yes (with assigned IP address)
IP address	-
Subnet mask	-
Gateway	
DNS server	-
Host name	Default setting: [serial number] 8 characters must be entered. Entry must be in Latin characters.

Note

Configure the DHCP server so that it always allocates the same IP addresses to the controllers. If a controller changes its IP address, it can no longer be found by the VCD software.

Sample Configuration with Fixed IP Address (for example, in small networks)

DHCP	No
IP Address	192.168.4.1 (PC with VCD software) 192.168.4.70 (Furnace 1) 192.168.4.71 (Furnace 2) 192.168.4.72 (Furnace 3) ...
Subnet Mask	255,255,255.0
DNS Server	0.0.0.0 (no DNS server) or 192.168.0.1 (example)
Host Name	Default: [serial number] The name is user defined (Latin letters). The number of entered characters must always be 8. The entry can only be made in Latin letters.

11.12.7 Setting the Wi-Fi Interface

This controller can be connected with the Internet via Wi-Fi in order to open the furnace status with the “MyNabertherm” app.

Setting the Wi-Fi interface			 ADMINISTRATOR
Procedure	Operation	Display	Comments
Select [Settings]			
Select [SYSTEM] and then [Wi-Fi Interface]			
Switch the interface on/off with [Enable Wi-Fi]			
Wi-Fi connected		Display: connected / not connected / disabled	Display the connection status
Select [SSID] and enter the name of a Wi-Fi network.			If you are unsure, ask your IT department about connection data.
Select [Password] and enter the network password.			If you are unsure, ask your IT department about connection data.
Select [Encryption]	<input type="radio"/> None <input type="radio"/> WPA 1 <input type="radio"/> WPA 2		If you are unsure, ask your IT department about connection data.
Select [Set up Wi-Fi] to start the Wi-Fi setup wizard.			If you are unsure, ask your IT department about connection data.
Select [Create app TAN] to connect a furnace in the “MyNabertherm” app.			Follow the instructions in the “MyNabertherm” app
Select [App connections] to delete linked users.			
Wi-Fi IPv4 address		e.g., 172.25.152.65	Display the Wi-Fi network address
Wi-Fi MAC address			Display the Wi-Fi MAC address
App server status		connected / not connected	Display the connection status for the app server
You do not have to save the changes.			

The rights that are required for the individual settings of the Wi-Fi connection can be seen in the following table:

Menu item	Display/Information	Rights to	User
		read/write	
Enable Wi-Fi	on/off	Read	-
		Write	Operator
Wi-Fi connected	Connected / not connected / disabled	Read	User "Change Wi-Fi"
		Write	Operator
SSID	Name of Wi-Fi network	Read	Operator
		Select	User "Change Wi-Fi"
Password	Wi-Fi key	Read (not plaintext)	Operator
		Write	User "Change Wi-Fi"
Encryption	None / WPA 1 / WPA 2		Operator
			User "Change Wi-Fi"
Set up Wi-Fi	As with initial start-up		User "Change Wi-Fi"
			User "Change Wi-Fi"
Create app TAN	Display TAN		User "Change Wi-Fi"
			Administrator
App connections	Connected e-mail addresses		Operator
			Operator
Wi-Fi IPv4 address	Assigned IP address		Operator
			User "Change Wi-Fi"
App server status	Connected / not connected		User "Change Wi-Fi"
			User "Change Wi-Fi"



Note

The user "Change Wi-Fi" is the user who was set in "User administration" → "User rights" → "Change Wi-Fi".

11.13 Importing and Exporting Process Data, Programs and Parameters



Note

If you do not have a functioning USB flash drive, you can purchase one from Nabertherm (part number 524500024) or download a list of tested USB flash drives. This list is part of the download file for the NTLog function (see information in "Saving Data on a USB Flash Drive with NTLog"). The corresponding file is called: "USB flash drives.pdf".

All the data in this controller can be saved on a USB stick (exported) or loaded (imported).

The following parameters are not taken into account for a parameter import:

- Controller type (User: [Service])
- Maximum possible temperature of the furnace (User: [Service])
- Information from the info-menu
- Passwords of the users
- Furnace power (User: [Service])
- Various monitoring parameters (over-temperature)

Saved data after a complete export on the USB stick	
Programs	File: [HOSTNAME]\PROGRAMS\prog.01.xml
Control Parameters	File: [HOSTNAME]\SETTINGS\parameter.pid.xml
Settings	File: [HOSTNAME]\SETTINGS\parameter.config.xml
Malfunctions	File: [HOSTNAME]\ERRORLOG\dump.error.xml
Process Data	File: [HOSTNAME]\ARCHIVE\20140705_14050102_0001.csv
Import Folder	Folder \IMPORT\...

The control parameters, settings and programs can also be individually exported or imported. When a complete export is performed all the files are saved on the USB stick.

The use of this function can be best explained by several examples:

- **Example 1 - Import of Programs:**
Three identical furnace should always be operated with the same program. The program is prepared using the controller, exported to a USB stick and re-imported to the other controllers. All controllers receive the same programs. Before importing, the exported data must always be copied to the IMPORT folder.
- Make sure that the prepared programs do not include any temperatures higher than the maximum temperature of the furnace. These temperatures will be not be accepted. The maximum number of controller segments and programs must not be exceeded. A message shows whether the program was imported successfully.
- **Example 2 - Import of PID Parameters:**
The control parameters of a furnace are optimized based on a temperature uniformity measurement. The control paramets can then be transferred to other furnaces or simply archived. Before importing, the exported data must always be copied to the import folder.
- **Example 3 - Forwarding the data by email to Nabertherm Service:**
In case of a service incident, Nabertherm Service requests that you save all the data to a USB stick. Then simply forward the data by email.



Note

If the controller breaks down, all the settings that the operator has entered are lost. The complete export of the data to a USB stick permit this data to be backed up. It can then be simply imported to a new, equivalent controller.



Caution

Files that you want to import must be saved on the USB stick in the folder "\IMPORT\". Do **NOT** create this folder in an exported folder of a controller. The "Import" folder must be on the top level.

When you perform an import, all the files in this folder are imported.

NO subfolders may be used!



Note

If you want to import files into the controller, the import process can fail if these files were previously changed. The import files must not be changed. If the import is not successful, make the necessary changes directly in the controller and export the files again.







Note

When you insert the USB flash drive, you will be prompted to decide what to save. A message is displayed while the operation unit writes or reads data. This can take up to 45 seconds. Do not remove the USB until the message is no longer displayed.

For technical reasons, all archive files on the controller are synchronized. Therefore, the time can vary depending on the size of the files.

IMPORTANT: Do not connect a PC, external hard drive or other USB host/controller here – under certain circumstances, you could damage both devices.

The following steps must be performed to export or import the data onto a USB stick:





Export or import data to a USB flash drive			 OPERATOR/ ADMINISTRATOR
Procedure	Operation	Display	Comments
Plug the USB into the connection/socket in the front of the controller			You must wait until the icon for the USB stops flashing.
Select [Settings]			
Select [SYSTEM] and then [IMPORT/EXPORT]			IMPORT is permitted only for [ADMINISTRATOR] users
Select which data is to be imported or exported			
Wait until the icon for the USB stops flashing.			
After importing parameters, switch the controller off, wait 10 seconds and switch it on again			See: <ul style="list-style-type: none"> - Switching Controller/Furnace Off - Switching Controller/Furnace On After importing PID parameters and programs, a restart is required.

Export or import data to a USB flash drive			 OPERATOR/ ADMINISTRATOR
Procedure	Operation	Display	Comments
Changes do not have to be saved.			

11.14 Registering Modules

If components, such as a control module or a control unit, are replaced, the modules have to be registered. This procedure is required to assign the module address to the control module. When a furnace is delivered, Nabertherm has already registered the modules.

Perform the following steps to register a module:

Registering a module			 ADMINISTRATOR
Procedure	Operation	Display	Comments
Select [Settings]			
Select [SERVICE]			
Select [MODULE CONFIGURATION]			
Select the desired module.			
Select [ADD MODULE]			The icon is on the right side
Press the small button on the top of the control module. You can access this via a small hole below the LED on the control module in the switchgear. Use a paper clip (if necessary, pinch off the thick end)			
When the module has been registered, assign an address to the module			Confirm the confirmation prompt
Changes do not have to be saved.			

The menu **[Bus Reset]** is for service purposes only.

11.15 Activating an Air Recirculator

This controller is able to activate an air recirculator. A recirculator can be destroyed by heat in case of a standstill. That is why the control of the air recirculator is controlled as a function of the furnace temperature.

As soon as a program was started at the controller, the air recirculation motor starts. They continue to operate until the program is completed or interrupted and the furnace temperature has fallen below a previously set value (e.g. 80 °C/176 °F).

This temperature dependent behavior always relates to the temperature of the master zone and during active charge control onto the thermocouple of the charge control.

The configuration of this function can only be performed at the factory and with the [Service] user.

In connect with a connected and door contact switch, set at the factory, this air recirculation function is extended again:

If the furnace is opened, the air recirculation motor is switched off. After 2 minutes, the air recirculation motor is automatically restarted, even if the door ist still open, to prevent a destruction of the air recirculator.

This function can also be similarly used for a door locking mechanism.

12 Information Menu

The information menu supports the rapid display of selected controller information.

Information menu			 OPERATOR
Procedure	Operation	Display	Comments
Select [Furnace]	■ ■ ■ ■ ■ ■ ■ ■ ■	An overview is displayed depending on the status of the program	
In the context menu, select [Info Menu]	■ ■ ■	The info menu is displayed	

The following information can be called in sequence:

Calling the data via the information menu	
Controller	Type and version of the controller
Serial number	Unique production number of the control unit
Error	Current error
Last errors	The last errors that occurred. The controller shows the error messages and warnings on the screen until they have been rectified and acknowledged. It may take up to one minute until these messages are saved in the archive.

Calling the data via the information menu	
<p>Statistics</p> <p>Please also observe the notes below this table</p>	<p>Maximum furnace temperature reached [°C]</p> <p>Last consumption in [kWh]</p> <p>Total consumption in [kWh]</p> <p>Operating hours, e.g., [1D 17 h 46min]</p> <p>Number of starts [17]</p> <p>Number of starts > 200 °C [17]</p> <p>Number of starts > 1200 °C [17]</p> <p>Maximum temperature of last firing [°C]</p>
<p>Module status</p>	<p>Display of current input and output statuses of a control module.</p> <p>[DA1/2] Digital outputs 1 and 2</p> <p>[AA1/AA2] Analog outputs 1 and 2</p>
<p>File name</p>	<p>Name of the process data file that is currently being recorded or was recorded.</p> <p>Example: [20140625_140400_0001].csv</p>
<p>Service export</p>	<p>If you confirm this menu entry with the button, all exportable information is saved on a plugged-in USB flash drive.</p> <p>Use this information within the scope of a service inquiry from Nabertherm Service, for example.</p> <p>This function is also available via the “Import/Export” function and is provided here simply because of its easier availability.</p> <p>If you do not have a functioning USB flash drive, you can purchase one from Nabertherm (part number 524500024) or download a list of tested USB flash drives. This list is part of the download file for the NTLog function (see information in “Saving Data on a USB Flash Drive with NTLog”). The corresponding file is called: “USB flash drives.pdf”.</p>



Caution

In order to be able to help quickly in case of an error, the values of the information menu are very helpful for localizing the error. In case of a malfunction, please fill out the printed check list in the "**Check List Controller Complaint**" section and place it at our disposal.



Note

The energy counter (kWh counter) calculates its value from the power output and a specified furnace power. If a regulator with non-linear behavior is used to control the heating (e.g. a phase section), this can lead to considerable deviations from the actual value when the energy consumption is being calculated.

13 Process Documentation

13.1 Saving Data on a USB Flash Drive with NTLog

This controller has an inbuilt USB interface for using a USB flash drive (no external hard disks or network drives).

Settings and programs can be imported and exported via this USB interface.

Another important function of this interface is saving process data for a current program on a USB flash drive.

It is unimportant whether the USB flash drive is inserted in the control unit during the heating program or afterwards. Each time the USB flash drive is inserted, all files that have been confirmed are copied from the control unit to the USB flash drive (up to 16 files).

▶ **Note**

If you do not have a functioning USB flash drive, you can purchase one from Nabertherm (part number 524500024) or download a list of tested USB flash drives. This list is part of the download file for the NTLog function (see information in “Saving Data on a USB Flash Drive with NTLog”). The corresponding file is called: “USB flash drives.pdf”.

▶ **Note**

During the current heating program, the process data is saved cyclically in a file on the internal memory of the controller. At the end of the heating program, the file is then copied to the USB flash drive (the USB flash drive must be formatted (file system FAT32) max. 2 TB).

Remember that a maximum of 16 heating programs can be saved in the controller memory. If the memory is full, the first process data file is overwritten. In other words, if you want to evaluate all process data, leave the USB flash drive plugged into the control unit or plug it in directly after the heating program ends.

The two files that are generated for each heating program have the following file names:

[HOST NAME]\ARCHIVE\[DATE]_[SERIAL NUMBER
CONTROLLER]_[CONSECUTIVE NUMBER].CSV

Example:

File: “20140607_15020030_0005.csv” and “20140607_15020030_0005.csv”

The consecutive number of the file name restarts from 0001 when 9999 is reached.

Files with the extension “.CSV” are used for evaluation with NTGraph (Nabertherm tool to display NTLog files) and Excel™.

**Note**

Information about NTLog and NTGraph

Nabertherm provides the “NTGraph” software for Microsoft Excel™ to display NTLog process data files (freeware).

This software and the corresponding documentation for NTLog and NTGraph can be downloaded at the following address:

<http://www.nabertherm.com/download/>

Product: NTLOG_C4eP4

Password: 47201410

The downloaded file has to be unzipped before you use it.

Before using NTGraph, read the instructions, which are also in the directory.

System requirements: Microsoft EXCEL™ 2003, EXCEL™ 2010, EXCEL™ 2013 or Office 365 for Microsoft Windows™.

The following data is saved in the files:

- Date and time
- Charge name
- File name
- Program number and name
- Serial number of the controller
- The heating program
- Comments about the progress and result of the heating program
- Version of the display unit
- Controller name
- Product group of the controller
- Process data

Process data table		
Process	Function	Description
Data 01	Program setpoint	Setpoint that is determined by the heating program that is entered
Data 02	Setpoint of zone 1	Setpoint for a zone. This consists of the program setpoint, the setpoint offset and the offset of the charge control.
Data 03	Temperature of zone 1	Measurement of the thermocouple for the zone
Data 04	Power of zone 1 [%]	Output of the controller for the zone in [0-100 %]
Data 05	Setpoint of zone 2	See above
Data 06	Temperature of zone 2	Measurement of the thermocouple for the zone or of a documentation thermocouple
Data 07	Power of zone 2 [%]	See above
Data 08	Setpoint of zone 3	See above
Data 09	Temperature of zone 3	Measurement of the thermocouple for the zone or of a documentation thermocouple

Process data table		
Process	Function	Description
Data 10	Power of zone 3 [%]	See above
Data 13	Temperature of the charge/documentation thermocouple	Measurement of the charge/documentation thermocouple
Data 14	Setpoint output of the charge control	Setpoint of the charge controller This consists of the program setpoint and the offset of the charge control.
Data 15	Temperature of the cooling thermocouple	Measurement of the cooling thermocouple
Data 16	Speed of the cooling fan [%]	Output of the controller for controlled cooling [0-100%]

The data that is available for your furnace depends on the furnace model. Data is saved with no decimal place.



Note
 When you insert the USB flash drive, you will be prompted to decide what to save. A message is displayed while the operation unit writes or reads data. This can take up to 45 seconds. Do not remove the USB until the message is no longer displayed.
 For technical reasons, all archive files on the controller are synchronized. Therefore, the time can vary depending on the size of the files.
IMPORTANT: Do not connect a PC, external hard drive or other USB host/controller here – under certain circumstances, you could damage both devices.

USB flash drive			
Procedure	Operation	Display	Comments
Plug the USB flash drive into the front of the control unit.		USB icon flashes	



Note
 The USB flash drive must **not** be removed while the message about writing or reading files is displayed. Otherwise, you could lose data.

The NTLog process documentation can be modified to suit personal and/or process requirements.

NTLog parameters			 SUPERVISOR
Procedure	Operation	Display	Comments
Select [Settings]			
Select [PROCESS DOCUMENTATION]			
Switch documentation on or off			
Interval Set the interval between 2 write processes		e.g., 60 seconds	Minimum setting 10 seconds. Nabertherm recommends an interval of 60 seconds to keep the data volume as low as possible.
[End of recording] Select the mode for the end of the process documentation		<p>The parameter [End of recording] decides when recording of a process data file is stopped.</p> <p>Two settings are possible:</p> <p>[Program End] Recording ends automatically when the heating program finishes. This is the default setting</p> <p>[BELOW LIMIT] [Temperature Undershot] Recording ends only when the temperature is below a certain threshold [LIMIT TEMPERATURE]. This setting is used to record cooling processes after the heating program is finished.</p>	
Change the limit temperature [End Temperature] for the end of process recording (factory setting = 100 °C)			Available only if [DOCU END] is set to [Temperature Undershot].
Set 24 h long-term recording		Long-term recording should be set if considerably more than 130,000 data records (approx. 90 days at 60-second intervals) are to be written to a file. This could be the case with infinite hold times or very long programs. In this case, the USB flash drive must remain inserted. A file is created for each day.	
Activate USB interface			This function must be activated to use the USB flash drive.



Note

In case of long-term recording, observe the maximum recording time. A maximum of approx. 130,000 data records can be recorded. A new file is created each day.

If long-term recording is not selected, up to 5,610 data records are recorded in each file. If the heating program takes longer, a new file is created with no interruption to the heating program. Up to 16 files are written and saved in the controller if no USB flash drive is inserted. Recording is then stopped.



Note

If there is a power outage, the last data records may be lost. When the power is restored, a new file for the data records is created.



Note

Before starting to record, make sure that the date and time are set correctly (see [Setting Date and Time])



Note

If you are using the NTLog functions, when you switch on the controller, check that the date and time are set correctly. If not, set them correctly. If the time setting is lost after the controller is switched on, replace the buffer battery in the controller.

13.2 Saving Process Data and Managing Programs with VCD Software (Option)

VCD software is provided by Nabertherm as an option to record and display process data from several controllers simultaneously. The software can be installed on a customer's PC. The controllers are extended with an Ethernet interface. The software has the following functions:

- Record setpoints and actual values from one or more Nabertherm controllers and display these in graphical and tabular formats
 Create and manage programs
 Extension packages (additional thermocouples, scales – only actual values)
- Connect selected Eurotherm controllers (3504, 3508)
- Available for Windows 7 (64 Bit) / Windows 10

14 Connecting to the MyNabertherm App

Series 500 controllers can be connected to an app for Android (from Version 9) and iOS (from Version 13). One or more furnaces can be linked via the app.

To link an app, access to the controller must be ensured.

The app has the following features:





- Displays process data
- Current program progress
- Push message from a furnace.

To link, carry out the following steps:

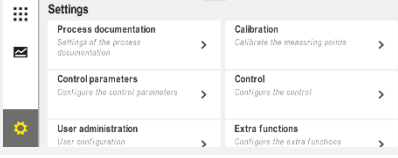

Note

Up to 9 app accounts can be linked to a furnace.



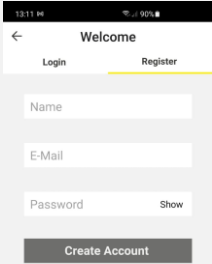

Switch on Wi-Fi on the controller and connect to the Internet			 SUPERVISOR
Procedure	Operation	Display	Comments
As an alternative to the following procedure, you can also restart the set-up wizard (see “Basic Functions”-> Initial Set-Up). You can also set up the Wi-Fi interface there.			
Before switching on Wi-Fi, make sure that there is a Wi-Fi network near the controller with a sufficiently strong signal and Internet access, If the signal is too weak, this can cause disconnections. If you require any help with this, contact your network provider or a local IT specialist.			
On the controller, select the [SETTINGS] menu			
Select [SYSTEM] and then [Wi-Fi INTERFACE]		Here, you can switch on the Wi-Fi connection. Enter the network password. Switch the Wi-Fi connection off again here if you do not want to allow external access.	The Wi-Fi interface supports WPA2 as encryption method.

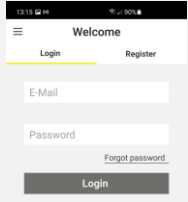
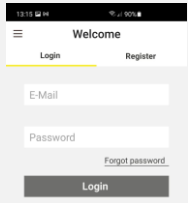
Register in the app now:

Registering in the app			
Procedure	Operation	Display	Comments
Download the “MyNabertherm” app from the Apple App Store or Google Play Store to your mobile phone and install it.			You will see a new icon. The app is available for iOS from Version 13 and Android from Version 9.
Start the app			
Register in the app or register directly if you are already logged in	If you want to remain logged in, select the function “Stay logged in”.		Register with your e-mail address and name. We use this data for authentication.
An e-mail with an activation link will be sent to the e-mail address you provided.	Confirm your registration via the link in the e-mail.	If you do not receive a confirmation e-mail, check your spam folder. Classify the sender as safe. If you cannot find the activation e-mail or if you deleted it accidentally, use the “Forgot password” function in the app to register again.	

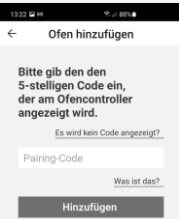

Registering in the app			
Procedure	Operation	Display	Comments
If necessary, log in to the app again.		You will see an empty furnace overview	
If you forgot your password, you can reset it using the link “Forgot password”.			A new e-mail will be sent to the user e-mail address. This contains a one-time password; enter this password and then choose a new password.

When you have logged in, you can add the first furnace in the app.

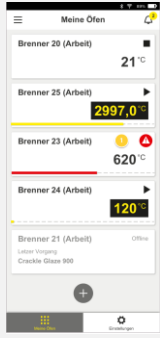

Adding a furnace in the app			
Procedure	Operation	Display	Comments
Add a furnace in the app by pressing the “+” icon in the furnace overview “My Furnaces”.			
You will be prompted to enter a TAN code. This TAN code has to be read from the controller.	Go to the furnace controller.		
Select the [Furnace Overview] menu on the controller.			
In the context menu of the controller, select [DISPLAY APP TAN]		The 5-digit APP TAN is displayed. This page closes after some time.	The app TAN is valid for just a few minutes. If the TAN expires, repeat the procedure.
Enter the app TAN in the app.	When you have entered the TAN, press [Add].		
In the app, go to the furnace overview again.			

Adding a furnace in the app			
Procedure	Operation	Display	Comments
The furnace is now shown as a tile. Tap a tile to go to the “Individual furnace view”.		The tile shows basic information, such as temperature, program progress and status of the furnace.	



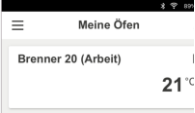

The individual furnace view provides a detailed overview of your furnace:

Individual furnace view			
Procedure	Operation	Display	Comments
Tap the tile of a furnace		If the furnace is not available, this is shown by a light gray font.	
You will see an overview clearly displaying the data of your furnace. Some data is shown only when a program is running.		Data: <ul style="list-style-type: none"> - Furnace name - Program name - Start time - Durations of programs and segments - Temperatures/power of the furnace - Segment information - Extra functions and program mode 	
In the context menu, you will find additional functions to manage the furnace or show details.		Functions of the context menu <ul style="list-style-type: none"> - Rename furnace - Remove furnace - Display process data - About this furnace - Help icon 	
Entries in the context menu	[Rename furnace]	Provides an option to change the name of the furnace. When the furnace was added in the app, the furnace name from the controller was used. This can be changed permanently in the app with this function. The original name remains in the controller.	
	[Remove furnace]	Deletes the furnace from apps with this account.	
	[Display process data]	Shows a list containing the current process data of the furnace.	
	[About this furnace]	Shows the serial number of the furnace, for example.	
	[Help icon]	Opens a help text containing short explanations about the different functions.	

If a furnace is to be removed from the app, the following steps are required. The furnace is removed from all apps with this e-mail address:

Removing a furnace in the app			
Procedure	Operation	Display	Comments
Select the furnace that is to be removed in “My Furnaces”. The individual furnace view opens			
In the context menu, select [Remove furnace]		A confirmation prompt is displayed. Confirm.	The furnace is removed in the app under “My Furnaces”

The furnace can also be removed from the app, using the controller

Removing a furnace in the app via the controller			 ADMINISTRATOR
Procedure	Operation	Display	Comments
Select [Settings] in the controller			
Select [SYSTEM] and then [Wi-Fi Interface]			
Select [App Links]		A list of the linked accounts (e-mail addresses) is displayed	
Select the account (e-mail address) whose link is to be deleted.	Press [REMOVE]	The account is deleted from the list.	The furnace is no longer displayed in the app.

14.1 Troubleshooting

FAQ		
Malfunction description	Cause	Troubleshooting
<ul style="list-style-type: none"> - Before switching on Wi-Fi, make sure that there is a Wi-Fi network near the controller with a sufficiently strong signal and also Internet access. If the signal is too weak, this can cause disconnection. If you require any help with this, contact your network provider or a local IT specialist. 		
The Wi-Fi icon in the status bar is crossed out	Wi-Fi is not activated in the router or the Internet provider has a malfunction.	<ul style="list-style-type: none"> - Test the Wi-Fi network with a mobile phone. - If there is a provider malfunction, contact your provider's support service
The connection from the app to the controller is completely or partially interrupted.	The signal is too weak	<ul style="list-style-type: none"> - Test the signal strength of the Wi-Fi with a mobile phone. Make sure that you are in the same Wi-Fi network as the controller - Use a repeater to increase the signal strength of the router
After you have registered, you do not receive a confirmation e-mail	The confirmation e-mail is in the spam folder	<ul style="list-style-type: none"> - Check the spam folder and classify the sender as safe

15 Communication with the Controller

Series 500 controllers have various options for communicating with external partners.

1. VCD software (Section [12.2])
2. Communication with superordinate systems via modbus TCP
3. Web server (on the Ethernet module) (Section [14.2])
4. App (Section [13])

15.1 Communication with Superordinate Systems via Modbus TCP

To connect the Series 500 controller, a communication module from version 1.8 is required on the controller. This communication module is the same module that is required to connect VCD software. Communication with a superordinate system is possible at the same time as communication with VCD software.

To connect the communication module via Modbus TCP, we recommend the M02.00021 instructions. Please contact Nabertherm Service.

15.2 Web Server

From Firmware Version V1.8, the communication module provides the option of visualizing process data in a JavaScript-capable browser (e.g. Google Chrome). The integrated web server on the communication module is used for this.



Note

To visualize the process data in a web browser, JavaScript must be enabled in the browser.

When the web browser has been started, enter the current IP address of the furnace or controller (default setting 192.168.4.70, see also section 10.11.5) in the address line.

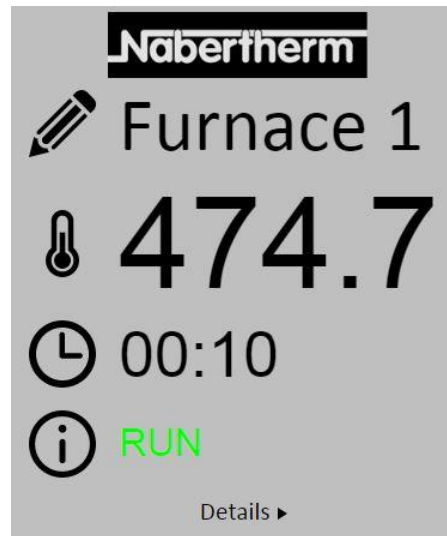







Fig. 4: Overview page of the web server

No.	Description
	Left-click the pencil icon to change the furnace name. Depending on the language, the length is limited.
	The current actual temperature (control temperature) of the furnace is shown next to this icon.
	The remaining time of the program is shown next to this icon.
	The furnace status is shown here.
	Left-click <i>Details</i> to open the details view.

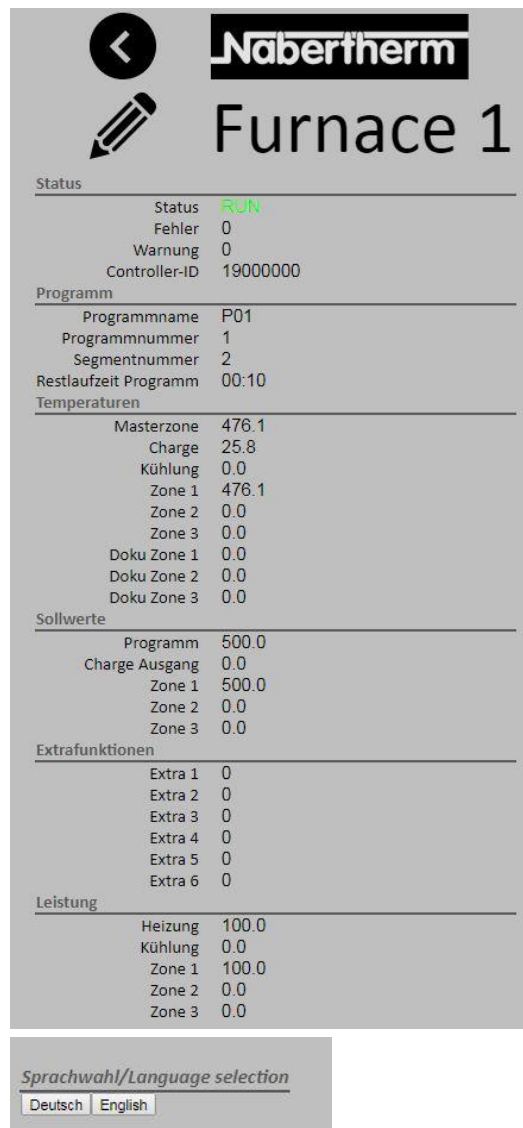

Fig. 5: Details view of the web server

All relevant process parameters and data are shown here.





German or English can be selected in the bottom left corner.

The web server can be used for all versions of the controller.

15.3 Retrofitting a Communication Module

15.3.1 Scope of Delivery

Retrofit kit:

Name	Quantity	Part number	Illustration
Communication module for the switchgear (from Version 0.16)	1	520100283 (520100279 for deliveries in exchange for the defective part)	
Back-wall connector for communications module	1	520900507	
Ethernet cable in the furnace: 1 m 90° angle	1	544300197	
Ethernet socket for feeding the network cable through the wall of the switchgear	1	520900453	

15.3.2 Installing a Communications Module



Warning - Danger of Electric Shock!

Only qualified and authorized electricians may work on electric equipment. During maintenance work, furnace and switchgear must be kept voltage-free to prevent accidental start-ups and secure all the movable parts of the furnace. Follow the specifications in the DGUV V3 or corresponding national regulations where the furnace is installed. Wait until the furnace chamber and its attachments have cooled down to room temperature.



DANGER

Control circuits for lighting and service sockets that are needed for maintenance purposes are not switched off by the power supply separation device (main switch) and remain live. The conductors for the wiring are colored (orange)

Tool to be made available





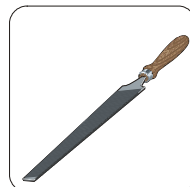



Screwdriver

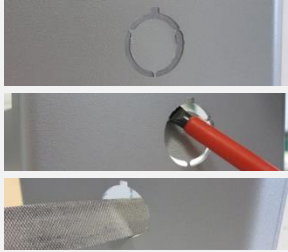

Metal file

Fig. 6: Tools

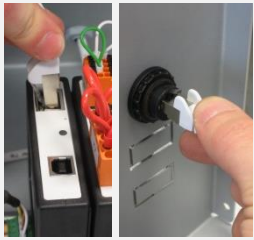
If you want to connect a furnace/controller that does not yet have a communications module, proceed as follows:

Illustration	Description
	<ol style="list-style-type: none"> 1. Open the switchgear cover on the furnace. 2. At the back of the switchgear, break open the pre-cut hole with a screwdriver. Pay attention to the small groove. It marks the correct hole.
	<ol style="list-style-type: none"> 3. When you have broken the hole open, push the enclosed Ethernet socket through from outside and screw it in place from the back with the nut.
	<ol style="list-style-type: none"> 4. Pull out the plug on the right of the module 5. Insert the enclosed plug here 6. Insert the plug that you pulled out into the new plug on the right <p>Note: Ensure correct wiring</p>
	<ol style="list-style-type: none"> 7. Press the communications module on to the rail so that the red bracket on the other side of the module also grips over the rail. Fix the module in place by pressing the red bracket towards the module. It must no longer be possible to lift the module from the rail.
	<ol style="list-style-type: none"> 8. Connect the module and the Ethernet socket with the short Ethernet cable (1 m).
	<ol style="list-style-type: none"> 9. Then connect the outside of the Ethernet socket with the PC with the long Ethernet cable (5 m). Connections >50m must be supported with a booster (e.g., switch). Depending on conditions at the installation location and the cables used, it may be necessary to use a switch or repeater even for shorter distances.

16 Over-Temperature Limiter with Manual Reset (Additional Equipment)



Over-temperature limiter (similar to picture)



Note

The functions of over-temperature limiters and over-temperature limiters with automatic reset (option) must be checked regularly.



Note

See additional operating instructions for description and function

17 Potential-Free Contact to Switch On an External Device and Receive Monitoring Signals (Option)

This function is used to activate and monitor an external device without having to activate it with an extra function. Activation is automatic and the device is switched off only below a set furnace temperature.

The external device can be monitored with a potential-free contact provided by the customer.

The function is explained using an external exhaust system as an example:

- The exhaust system starts when the firing program starts
- The exhaust system switches off at the end of the program and the furnace then cools to below 80 °C
- Monitoring an alarm contact from the customer that interrupts the current furnace program and switches off the heating when an external signal is received (e.g., breakdown of the customer's exhaust system or general external alarm). Several contacts can be combined. Configured either in series (as normally closed contacts) or in parallel (as normally open contacts). When the alarm has been acknowledged, the furnace program continues.
- No warranty for the function of the exhaust system, no technical safety assessment according to EN ISO 13849

18 Error Messages and Warnings

The controller shows the error messages and warnings on the screen until they have been rectified and acknowledged. It may take up to one minute until these messages are transferred to the archive.

18.1 Error Messages of the Controller

ID+ Sub-ID	Text	Logic	Remedy
Communication error			
01-01	Bus zone	Communication connection to a control module disrupted	Check that the control module is firmly attached LEDs on the control modules red? Check the cable between the control unit and the control module Plug of the connection cable not plugged correctly into the control unit
01-02	Bus communications module	Communication connection to the communications module (Ethernet/USB) disrupted	Check that the communications module is firmly attached Check the cable between the control unit and the communications module
Sensor error			
02-01	TC open		Check thermocouple, thermocouple terminals and cable Check contacts of the thermocouple cable in plug X1 on the control module (contacts 1+2)
02-02	TC Connection		Check the set thermocouple type Check poles of thermocouple connection
02-03	Compare point error		Control module defective
02-04	Compare point too hot		Temperature in the switchgear too high (approx. 70 °C) Control module defective
02-05	Compare point too cold		Temperature in the switchgear too low (approx. -10 °C)
02-06	Encoder separated	Error at the 4-20 mA input of the controller (<2 mA)	Check 4-20 mA sensor Check the connection cable to the sensor
02-07	Sensor element defective	PT100 or PT1000 sensor defective	Check PT sensor Check connection cable to the sensor (cable break/short circuit)

ID+ Sub-ID	Text	Logic	Remedy
System error			
03-01	System memory		Error after firmware updates ¹⁾ Defective control unit ¹⁾
03-02	ADC error	Communication between AD converter and controller disrupted	Replace control module ¹⁾
03-03	File system defective	Communication between display and memory chip disrupted	Replace control unit
03-04	System monitoring	Program execution on the control unit defective (Watchdog)	Replace control unit USB flash drive removed too soon or defective Switch controller off and on again
03-05	Zone system monitoring	Program execution on a control module defective (Watchdog)	Replace control module ¹⁾ Switch controller off and on again ¹⁾
03-06	Self-test error		Contact Nabertherm Service ¹⁾
Monitoring			
04-01	No heater power	No temperature increase in the ramps when heating output \leq 100 % for 12 minutes and when the temperature setpoint is higher than the current furnace temperature	Acknowledge the error (if necessary, disconnect from the power supply) and check safety contactor, door switch, heating controls and controller. Check heating elements and heating element connections. Lower D value of the control parameters.
04-02	Excess temperature	The temperature of the control zone exceeds the max. program setpoint or the maximum furnace temperature by 50 Kelvin (from 200 °C) The equation for the switch off threshold is: Maximum program setpoint + zone offset of the master zone + charge control offset [Max] (if charge control active) + excess temperature switch-off threshold (P0268, e.g., 50 K)	Check solid state relay Check thermocouple Check controller (from V1.51 with 3 minute delay)

ID+ Sub-ID	Text	Logic	Remedy
		A program was started at a furnace temperature higher than the maximum setpoint in the program	Do not start the program until the furnace temperature is lower. If this is not possible, insert a hold time as a start segment and then a ramp with the desired temperature (STEP=0 minutes duration for both segments) Example: 700 °C -> 700 °C, Time: 00:00 700 °C -> 300 °C, Time: 00:00 The normal program begins here From Version 1.14, the actual temperature is also considered at the start. (from V1.51 with 3 minute delay)
04-03	Power failure	The set limit for restarting the furnace was exceeded	If possible, use an uninterruptible power supply
		The furnace was switched off at the main switch during the program	Stop the program on the controller before you switch off the main switch
04-04	Alarm	A configured alarm was triggered	
04-05	Auto-tune failed	The determined values are implausible	Do not carry out auto-tune at the lower temperature range of the furnace working range
	Battery weak	Time is not shown correctly. A power failure may no longer be handled properly.	Export all parameters to a USB flash drive Replace the battery (see “Specifications”)
Other malfunctions			
05-00	General malfunction	Malfunction in the control module or Ethernet module	Contact Nabertherm Service Provide the service export

¹⁾ The error can only be acknowledged by switching off the controller.

18.2 Warnings of the Controller

Warnings are not displayed in the error archive. They are only displayed on the display and in the file of the parameter export. Warning do not generally lead to a program crash.

No.	Text	Logic	Remedy
00	Gradient monitoring	The limit value of the configured gradient monitoring was exceeded	For troubleshooting, refer to “Gradient Monitoring” Gradient set too low
01	No control parameters	No “P” value was entered for the PID parameters	Enter at least one “P” value in the control parameters. It must not be “0”

No.	Text	Logic	Remedy
02	Charge thermocouple defective	No charge thermocouple was determined with the current program and activated charge control	Plug in a charge thermocouple Disable charge control in the program Check the charge thermocouple and its cable for damage
03	Cooling thermocouple defective	The cooling thermocouple is not plugged in or is defective	Plug in a cooling thermocouple Check the cooling thermocouple and its cable for damage If there is a malfunction in the cooling thermocouple during active controlled cooling, the system switches over to the thermocouple of the master zone.
04	Documentation thermocouple defective	Either no documentation thermocouple or a defective one was determined.	Plug in a documentation thermocouple Check the documentation thermocouple and its cable for damage
05	Power failure	A power failure was determined. There was no program interrupt	None
06	Alarm 1 - Band	The configured band alarm 1 was triggered	Optimize the control parameters Alarm set too narrowly
07	Alarm 1 - Min	The configured min. alarm 1 was triggered	Optimize the control parameters Alarm set too narrowly
08	Alarm 1 - Max	The configured max. alarm 1 was triggered	Optimize the control parameters Alarm set too narrowly
09	Alarm 2 - Band	The configured band alarm 2 was triggered	Optimize the control parameters Alarm set too narrowly
10	Alarm 2 - Min	The configured min. alarm 2 was triggered	Optimize the control parameters Alarm set too narrowly
11	Alarm 2 - Max	The configured max. alarm 2 was triggered	Optimize the control parameters Alarm set too narrowly
12	Alarm - External	The configured alarm 1 at input 1 was triggered	Check the source of the external alarm
13	Alarm - External	The configured alarm 1 at input 2 was triggered	Check the source of the external alarm
14	Alarm - External	The configured alarm 2 at input 1 was triggered	Check the source of the external alarm
15	Alarm - External	The configured alarm 2 at input 2 was triggered	Check the source of the external alarm
16	No USB flash drive inserted		When exporting data, insert a USB flash drive in the controller

No.	Text	Logic	Remedy
17	Import/export of data via the USB flash drive unsuccessful	The file was edited with a PC (text editor) and saved in the wrong format or the USB flash drive was not detected. You want to import data that is not in the import folder on the USB flash drive	Do not edit XML files with a text editor, only in the controller. Format the USB flash drive (format: FAT32). No quick formatting Use a different USB flash drive (to 2 TB/FAT32) When importing, all data must be in the import folder on the USB flash drive. The maximum storage capacity for USB flash drives is 2 TB/FAT32). If you experience problems with your USB flash drive, use a different USB flash drive with maximum 32 GB
	Programs are rejected during the import of programs	Temperature, time or rate are outside the limit values	Import only programs that are suitable for the furnace. The controllers differ as regards the number of programs and segments and the maximum furnace temperature.
	While programs are being imported, "Error occurred" is displayed	The complete parameter set (at least the configuration files) was not stored in the "Import" folder on the USB flash drive	If you deliberately left out files during import, ignore the message. Otherwise, check the completeness of the import files.
18	"Heating blocked"	This message is displayed if a door switch is connected to the controller and the door is open	Close the door Check the door switch
19	Open door	The furnace door was opened while a program was running	Close the door while a program is running.
20	Alarm 3	General message for this alarm number	Check the cause of this alarm message
21	Alarm 4	General message for this alarm number	Check the cause of this alarm message
22	Alarm 5	General message for this alarm number	Check the cause of this alarm message
23	Alarm 6	General message for this alarm number	Check the cause of this alarm message
24	Alarm 1	General message for this alarm number	Check the cause of this alarm message
25	Alarm 2	General message for this alarm number	Check the cause of this alarm message
26	Multi-zone holdback temperature exceeded	A thermocouple that was configured for multi-zone holdback has left the temperature band downward	Check whether the thermocouple is necessary for monitoring. Check the heating elements and their activation
27	Multi-zone holdback temperature undershot	A thermocouple that was configured for multi-zone holdback has left the temperature band upward	Check whether the thermocouple is necessary for monitoring. Check the heating elements and their activation

No.	Text	Logic	Remedy
28	Modbus connection interrupted	The connection to the superordinate system was interrupted.	Check if the Ethernet cables are damaged. Check the configuration of the communication connection

Note

If you do not have a functioning USB flash drive, you can purchase one from Nabertherm (part number 524500024) or download a list of tested USB flash drives. This list is part of the download file for the NTLog function (see information in “Saving Data on a USB Flash Drive with NTLog”). The corresponding file is called: “USB flash drives.pdf”.

18.3 Malfunctions of the Switchgear

Error	Cause	Remedy
Controller does not light up	Controller is switched off	Switch the power switch to “I”
	No power available	Is the power cord plugged into the socket? Check the building fuses. Check the fuse of the controller (if present) and replace it if necessary.
	Check the fuse of the controller (if present) and replace it if necessary.	Switch the power switch on. If the error occurs again, contact Nabertherm Service
Controller displays error	See the separate instructions of the controller	See the separate instructions of the controller
Furnace does not heat	Door / cover is open	Close the door / cover
	The door contact switch is faulty (if present)	Check the door contact switch
	"Delayed Start" is displayed	The program is waiting for the programmed start time. Deselect delayed start above the start button.
	Error in entering the program	Check the heating program (see the separate instructions of the controller)
	Heating element defective	Have this checked by Nabertherm Service or a qualified electrician.
Very slow heating of the heating space	The fuse(s) of the connection is/are defective.	Check the fuse(s) of the connection and replace if necessary. Notify Nabertherm service if the new fuse fails again immediately.

Error	Cause	Remedy
The program does not jump to the next segment	In one TIME segment in the program input, the wait time is set to INFINITE If charge control is activated, the temperature of the charge is higher than the zone temperatures.	Do not set the wait time to INFINITE
	If charge control is activated, the temperature of the charge is higher than the zone temperatures.	The parameter [LOWER BLOCK] must be set to [NO].
The controller module can not be registered on the operating unit	Addressing error of the controller module	Perform a bus reset and re-address the controller module
The controller is not heating in the optimization	No optimization temperature has been set	The temperature to be optimized must be entered (see the separate instructions of the controller)

The temperature rises faster than the controller setting allows	<p>The switch element of the heating unit (semiconductor relay, thyristor or switch contactor) is defective.</p> <p>Individual defective components inside a furnace cannot be completely ruled out in advance. That is why the controllers and the switchgear units must be equipped with safety facilities. For example, the furnace shuts down the heating unit in response to error message 04 - 02 via an independent contact element.</p>	Have the switch element tested by a qualified electrician and replaced as necessary.
--	---	--

18.4 Controller Check List

Customer:	
Furnace model:	
Controller model:	
Controller version (see info menu):	
Controller serial number:	
Furnace serial number:	
Error code in display:	
The following malfunctions are dependent on external influences:	02-05 ambient temperature too low: < -10 °C (14 °F) 02-04 ambient temperature too high: > 70 °C (158 °F)
Exact description of fault:	

Export service information:		Export all data to a USB flash drive. To do this, plug a USB flash drive into the controller and select “Service”. Use the ZIP function (compression) integrated in Windows to make a ZIP file of the exported folder (see “Importing and Exporting Data and Parameters”) and send this to your contact at Nabertherm Service.	
When does the malfunction occur?		At certain points in the program or times of day:	
		At certain temperatures:	
When did the malfunction first occur?		<input type="checkbox"/> The malfunction is new	
		<input type="checkbox"/> The malfunction has existed for some time	
		<input type="checkbox"/> Unknown	
Malfunction frequency:		<input type="checkbox"/> Malfunction occurs frequently	
		<input type="checkbox"/> Malfunction occurs regularly	
		<input type="checkbox"/> Malfunction occurs rarely	
		<input type="checkbox"/> Unknown	
Replacement controller:	Has a replacement controller been used?	<input type="checkbox"/> Yes	<input type="checkbox"/> No
	Is the malfunction still present when the replacement controller is used?	<input type="checkbox"/> Yes	<input type="checkbox"/> No
	Checked according to troubleshooting list (see Furnace Operating Manual)	<input type="checkbox"/> Yes	<input type="checkbox"/> No

Enter the following test program to heat the furnace at full power:

Point in program	Value
Segment 01- Start temperature	0 °C
Segment 01- Target temperature	500 °C
Segment 01- Time	5 minutes
Segment 01- Target temperature	500 °C

Close the door/lid and start the test program

Check the following:

- Is the furnace heating (temperature increase)?
- Does the display show the “heat” icon?

In the heating phase, open the info menu for more detailed information.

Date: _____ Name: _____ Signature: _____

**Note**

If you do not have a functioning USB flash drive, you can purchase one from Nabertherm (part number 524500024) or download a list of tested USB flash drives. This list is part of the download file for the NTLog function (see information in “Saving Data on a USB Flash Drive with NTLog”). The corresponding file is called: “USB flash drives.pdf”.

19 Specifications



Furnace data related to electrical power are on the type plate located on the side of the furnace. The type plate of each of the controllers is located on the controller modules in the switchgear.

Controller Series 500-1 (B500/B510, C540/C550, P570/P580)		
Supply voltage:	Controller power adapter: ~100 V – 240 V 50/60 Hz Controller: 12 V DC	The adapter must not be used for other devices
Power consumption (12 V circuit):	Maximum 300 mA for the control unit Maximum 235 mA per power unit Maximum 50 mA for the communication module Maximum 50 mA per power unit as charge control	Power consumption with 3 zone modules, 1 charge module, 1 cooling module and 1 communications module: Approx. max. 1110 mA
Sensor input:	TC thermocouple TC 0-10 V TC 4-20 mA PT1000 PT100	Parameterization only by Nabertherm
Thermocouple types:	Type B/C/E/J/K/L/N/R/S/T	Parameterization only by Nabertherm
Digital inputs 1 and 2:	12 V, max. 20 mA	Use potential-free contact
Analog outputs 1 and 2:	Constant 0 – 5 V, 0 – 10 V, maximum 100 mA Output actual value, setpoint and max. setpoint of the segment with 1-9V (0-Tmax). The range outside these limits should be considered an invalid signal.	Analog output, digitally switched. I _{max} approx. 100 mA)
Safety relay:	240 Vac / 3 A with ohmic load, preliminary fuse max. 6.3 A (C-characteristic)	
Extra relay:	240 Vac / 3 A with ohmic load, preliminary fuse max. 6.3 A (C-characteristic)	The two extra relays of a module must only be supplied with one voltage. Voltages must not be mixed. If this is the case, another module must be used.
Real-time clock:	Yes	
Buzzer:	Connect externally via output	

Controller Series 500-1 (B500/B510, C540/C550, P570/P580)		
	3 V/285 mA Lithium Model: CR2430	When the battery is replaced, dispose of the used one properly. Batteries must not be disposed of with household waste.
Protection type:	Mounted housing: IP40 with closed USB interface cover.	
	Control module/power adapter: IP20	
	Furnace/switchgear	(See furnace/switchgear instructions)
Interface:	USB host integrated (USB flash drive)	No other devices, such as hard disks or printers, may be connected. Maximum size: to 2 TB, formatting: FAT32
	Ethernet/USB device	Optionally available as a module 10/100 Mbps (auto-sensing) Automatic correction of crossed lines (cross-over detection) Operating system: Keil RTX Frequency: 2.412 Ghz to 2.484 Ghz Power: 15 dBm = max. 32.4 mW Ports: 1912 Standard: IEEE802.11b/g/n Host: get-entangled.de
	Wi-Fi	Encryption: WPA 2 Frequency band: 2.4 GHz
Measurement accuracy:	+/- 1 °C, 16 bit input card	
Lowest possible rate:	1 °C/h when the rate is entered in the program	
Ambient conditions (according to EN 61010-1):		
Storage temperature:	-20 °C to +75 °C	
Working temperature:	+5 °C to +55 °C	Ensure sufficient air circulation
Relative humidity:	5 – 80% (to 31 °C, 50% at 40 °C)	not condensing
Height:	< 2000 m	

19.1 Type Plate

On controllers B500/C540/P570, the type plate is on the back of the housing.

On controllers B510/C550/P580, the type plate is near the control unit, possibly in the switchgear.



Fig. 7: Example (type plate of the control unit)

20 Cleaning

The surface of the device can be cleaned with a mild soap solution.

Use only a dry cloth to clean the USB interface.

Do not treat the stickers/signs with strong or alcohol-based cleaning products. After cleaning the screen, dry it thoroughly with a lint-free cloth.

21 Maintenance and Spare Times

As shown in the section "Construction of the Controller", the controller consists of several components. The controller modules are always installed in the interior of the switchgear cabinet or the furnace housing. The control unit can be installed in a switchgear cabinet or in the furnace housing. Moreover, there are furnace models whose control unit is attached to the furnace housing so that it can be taken off. The ambient conditions are described in the section "Technical Data".

You must prevent conductive dirt and dust from entering the switchgear cabinet or the furnace housing.

To minimize the coupling of malfunctions into the control and measurement range, you must ensure that they are kept separate and laid as far apart as possible from power lines. If this is not possible, sheathed cable must be used.



Warning – Danger of Electric Shock!

Work on the electrical equipment may be done only by qualified, authorized electricians.

Make sure that the power switch is set to "0"!

Pull the power plug before you open the housing!

If the furnace has no power plug, cut off the power to the fixed connection.

21.1 Replacing a Controller

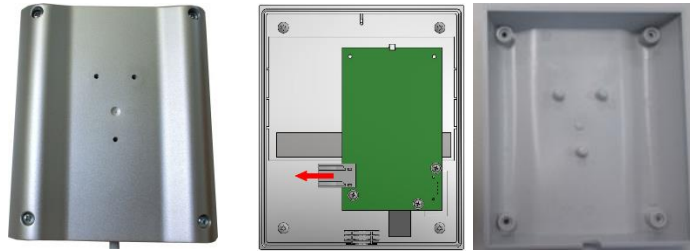

Fig. 8: Replacing a controller (similar to picture)

- Remove the 4 screws on the back side of the housing with a Phillips-tip screwdriver. Depending on the variant, these may be Phillips or Torx.
- Carefully pull the two parts of the housing apart.
- Undo the cable from the board by pressing the two orange colored elements on the plug and carefully removing it.
- You can now insert the plug on the board of the new controller.
- Screw the back of the housing on again.
- If a control module was also delivered, replace this too. Proceed as described in “Removing the Controller Modules”.

21.2 Removing the Controller Modules

- Disconnect the connections to the module by carefully pulling on the connector.
- To remove the module from the fastening bar, apply downward leverage with a flat-tip screwdriver to the red unlocking device.

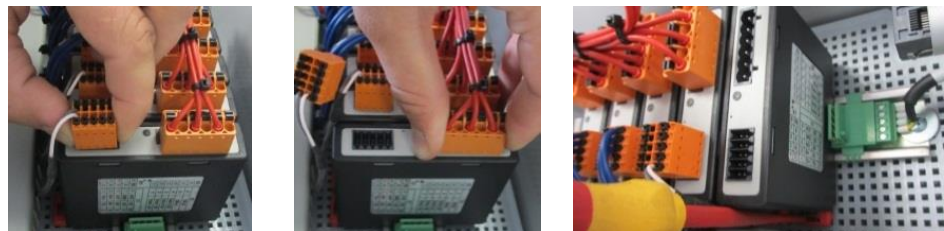

Fig. 9: Removing the controller module - part 1 (similar to picture)

At the same time, tilt the component carefully upwards. Then you can remove it from the switchgear.

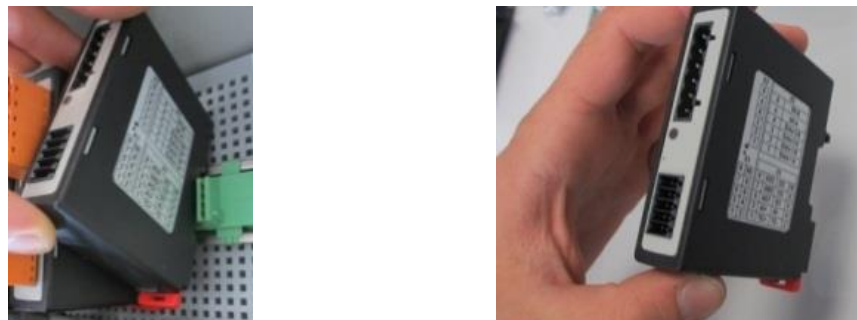

Fig. 10: Removing the controller module - part 2 (similar to picture)

21.3 Installing the Controller Module

- Hook the module into the fixing rail top first.
- Then tilt the module downward and allow it to engage.
- Carefully press the plug into the module. Make sure that the plug is pushed into the module as far as it can go. You feel the plug engaging. If not, increase the pressure.

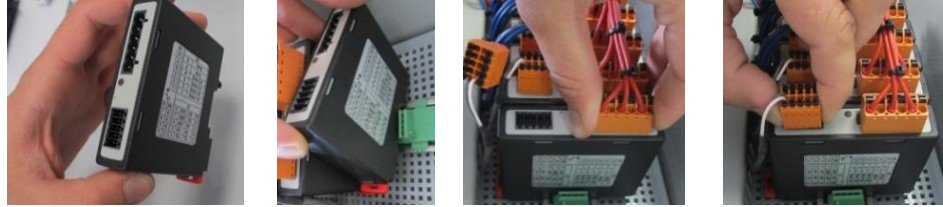

Fig. 11: Installing the controller module (similar to picture)

22 Electrical Connections

The following sample circuits illustrate different circuit variants. The final circuitry of the components is only permissible after having been checked by a qualified professional.

22.1 Controller Module

Every controller has at least one controller module in the switchgear. The controller consists of this controller module, together with the operating and display unit and a power adapter.

The overview shows the components:

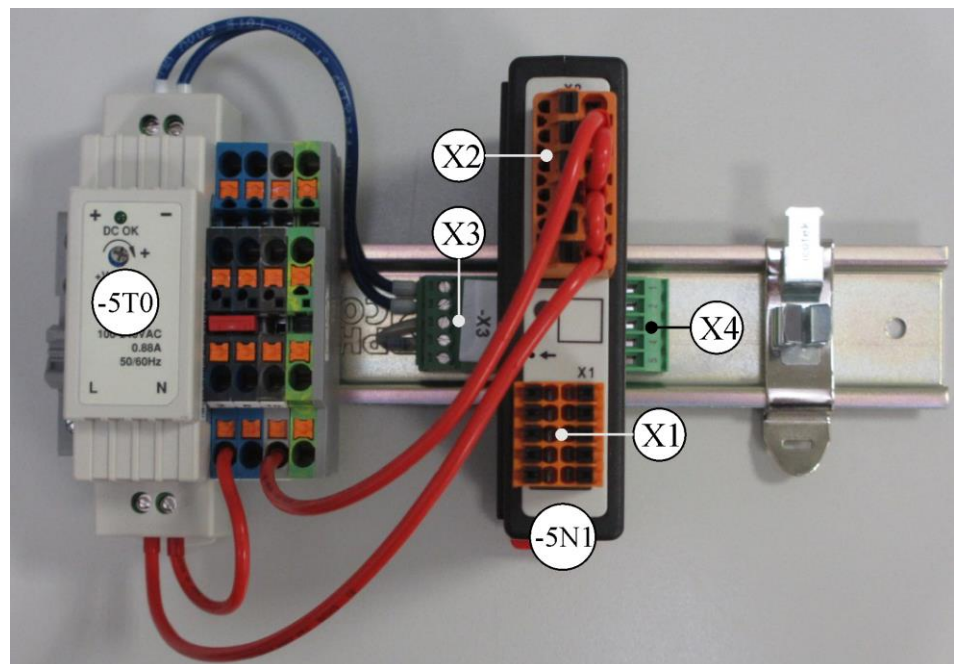

-5T0 = Power adapter

-5N1 = Controller module

Fig. 12: Power adapter and controller modules (similar to picture)

22.2 Power Line Requirements

For lines carrying mains voltage: Use 18 AWG or 1 mm² lines (multinorm line, 600 V, max. 105 °C, PVC insulation) and ferrules with insulation compliant with DIN 46228.

For lines carrying 12 V direct current: Use 20 AWG or 0.5 mm² (multinorm line, 600 V, max. 90 °C, brief periods 105 °C, PVC insulation) and ferrules with insulation compliant with DIN 46228.

22.3 General Connection

The following connection schematic includes all the possible wirings of the controller modules for single-zone furnaces.

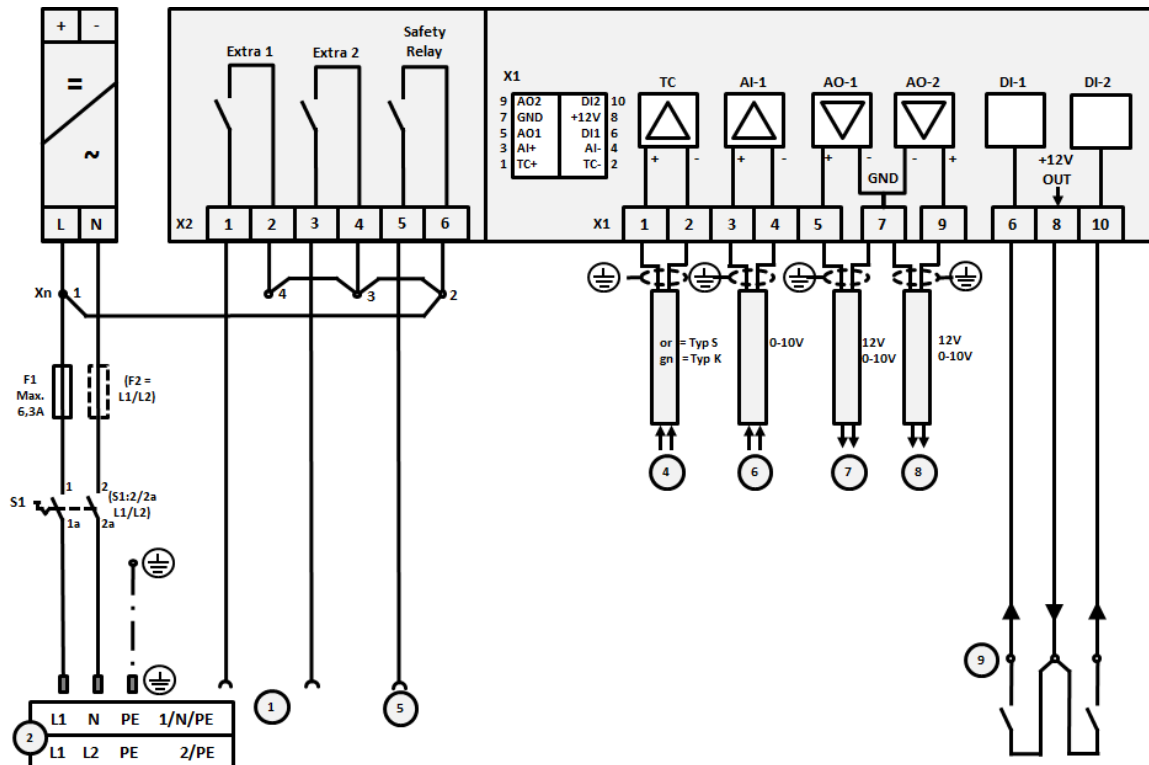

Fig. 13: General connection

No.	Explanation
1	Outputs for extra functions
2	Power supply
3	-
4	Thermocouple connection or 4-20 mA with load 47 Ohm
5	Output for safety relay
6	Analog input (0-10 V)
7	Analog output 1 (heating activation 12 V or 0-10 V; output actual value, setpoint and max. setpoint of the segment with 1-9V (0-Tmax). The range outside these limits should be considered an invalid signal.) Contactor actuation via converter relay
8	Analog output 2
9	Connections of potential-free contacts at inputs 1 and 2

22.4 Furnaces up to 3.6 kW – Replacement for B130, B150, B180, C280, P330 to 12.2008

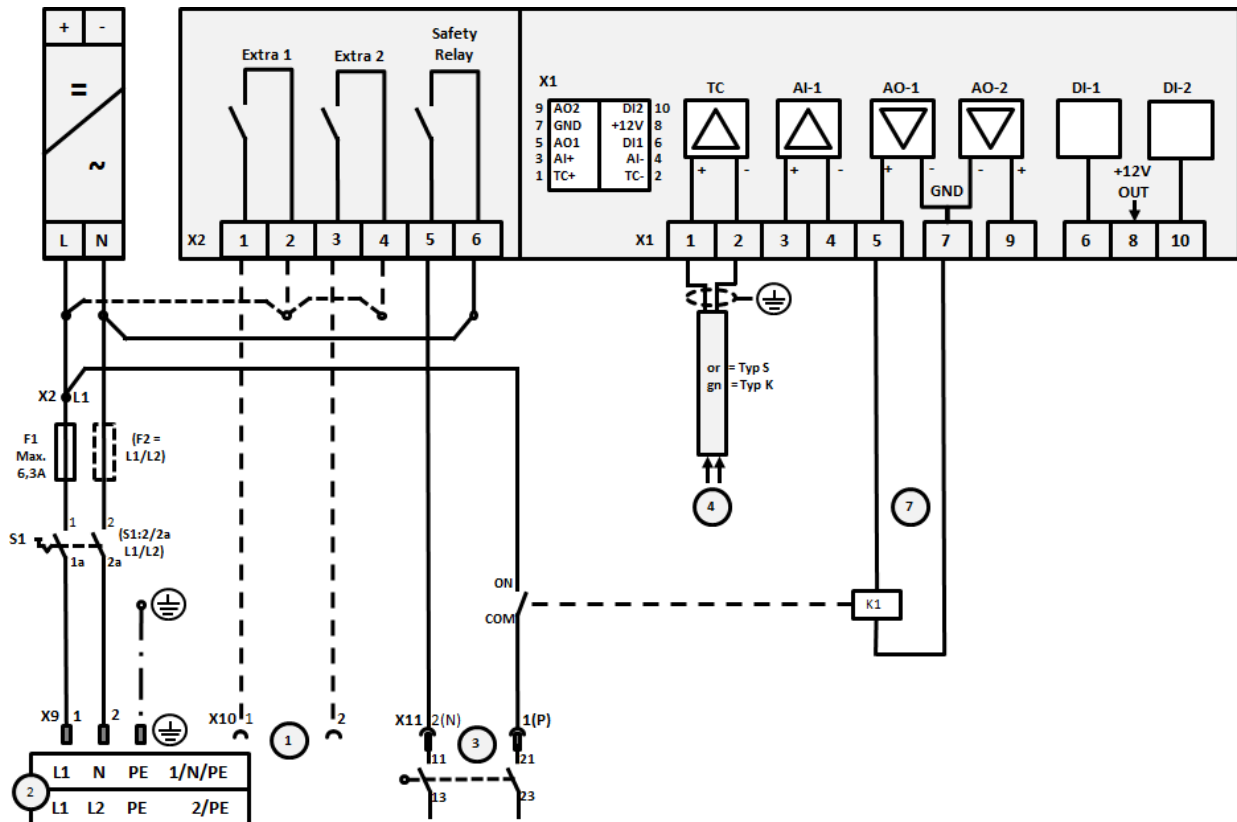

Fig. 14: Connection of furnaces up to 3.6 kW (to 12.2008)

No.	Explanation
1	Outputs for extra functions (option)
2	Power supply
3	Heating connection, see furnace instructions
4	Thermocouple connection
5	-
6	-
7	Heating activation 12 V or 0-10 V; output actual value, setpoint and max. setpoint of the segment with 1-9V (0-Tmax). The range outside these limits should be considered an invalid signal. Contactor actuation via converter relay
8	-
9	-

22.5 Furnaces up to 3.6 kW – Replacement for B130, B150, B180, C280, P330 from 01.2009

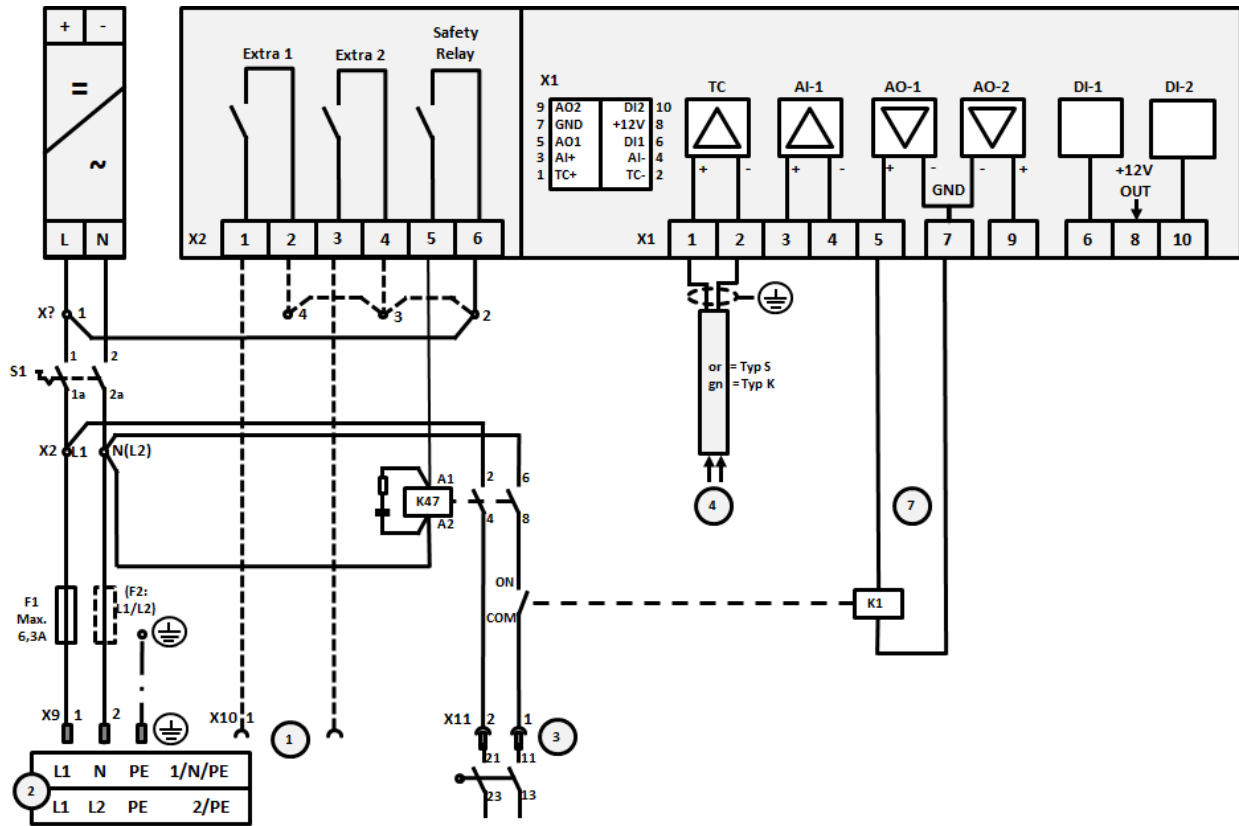

Fig. 15: Connection of furnaces up to 3.6 kW (from 01.2009)

No.	Explanation
1	Outputs for extra functions (option)
2	Power supply
3	Heating connection, see furnace instructions
4	Thermocouple connection
5	-
6	-
7	Heating activation 12 V or 0-10 V; output actual value, setpoint and max. setpoint of the segment with 1-9V (0-Tmax). The range outside these limits should be considered an invalid signal. Contactor actuation via converter relay
8	-
9	-

22.6 Furnaces, Single-Zone > 3.6 kW with Semi-Conductor Relay or Protection

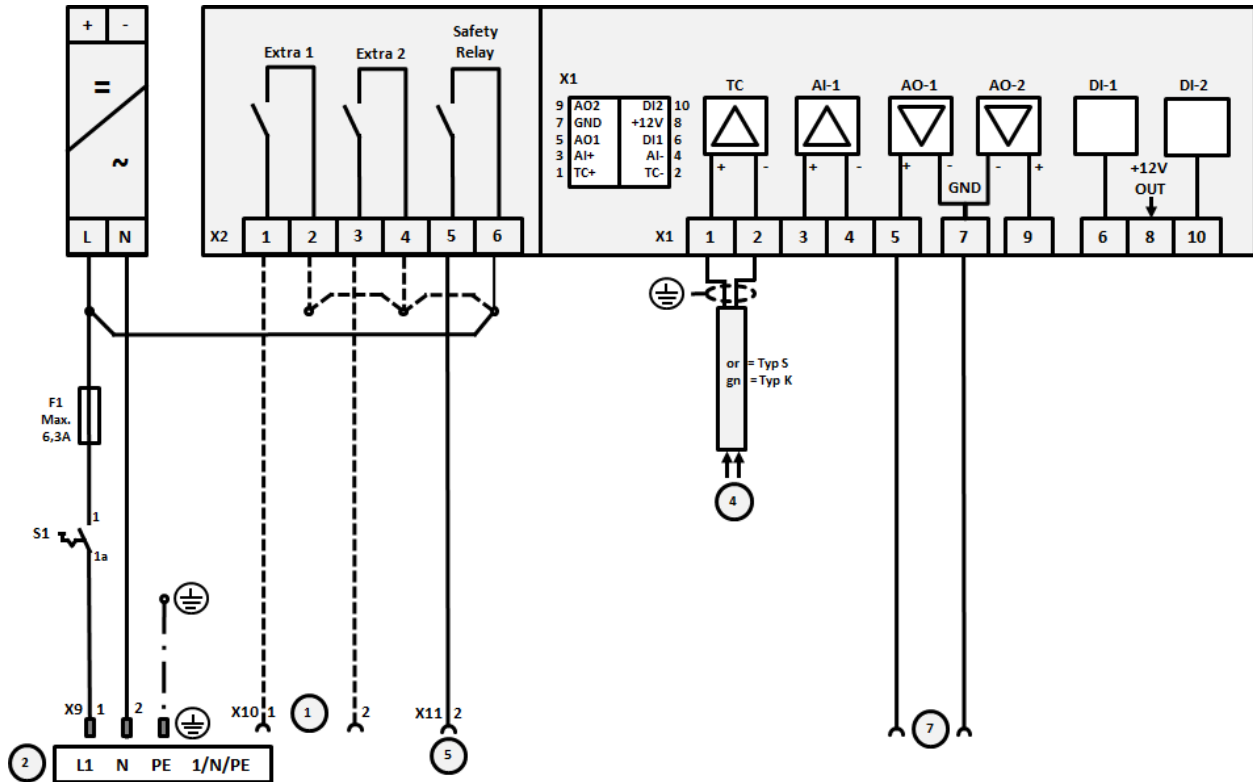

Fig. 16: Connection of furnaces above 3.6 kW, single zone

No.	Explanation
1	Outputs for extra functions (option)
2	Power supply
3	-
4	Thermocouple connection
5	Output for safety relay
6	-
7	Heating activation 12 V or 0-10 V; output actual value, setpoint and max. setpoint of the segment with 1-9V (0-Tmax). The range outside these limits should be considered an invalid signal. Contactor actuation via converter relay
8	-
9	-

22.7 Furnaces > 3.6 kW with 2 Heating Circuits

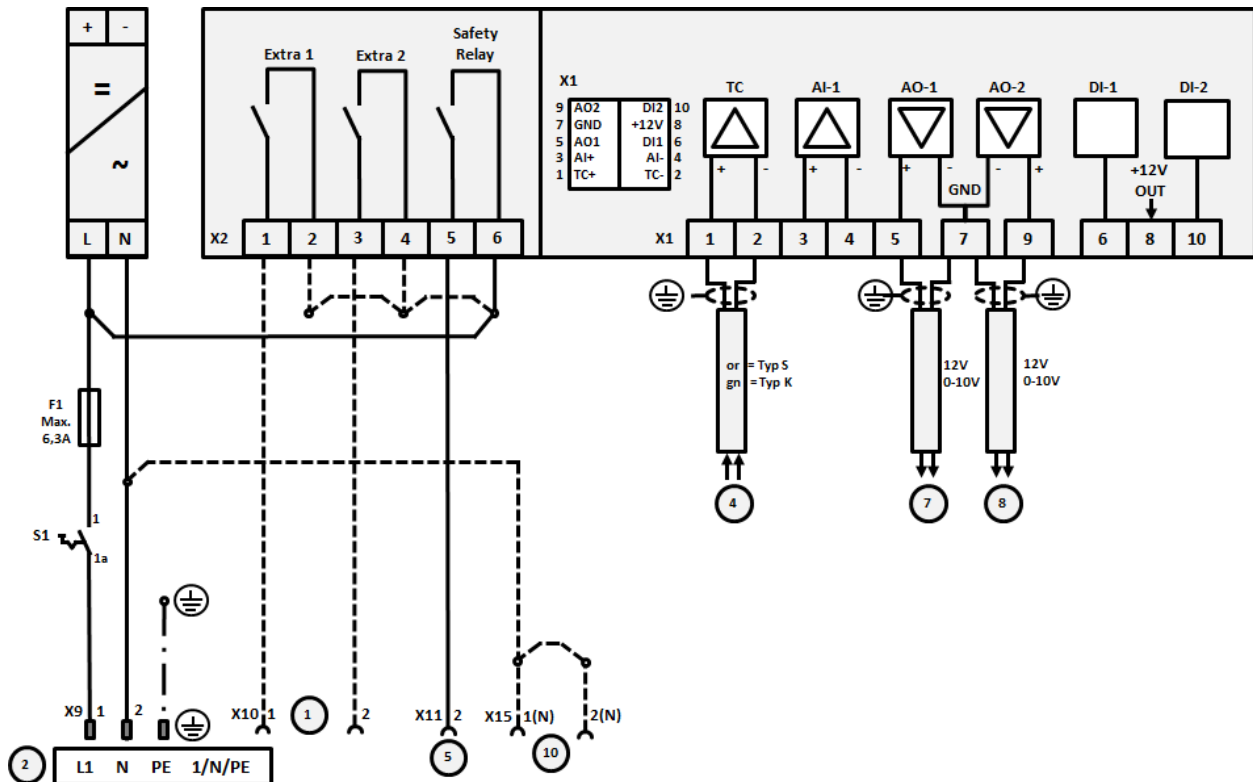

Fig. 17: Connection of furnaces above 3.6 kW with two heating circuits

No.	Explanation
1	Outputs for extra functions
2	Power supply
3	-
4	Thermocouple connection
5	Output for safety relay
6	-
7	Heating activation 12 V or 0-10 V heating circuit 1; output actual value, setpoint and max. setpoint of the segment with 1-9V (0-Tmax). The range outside these limits should be considered an invalid signal. Contactor actuation via converter relay
8	Heating activation 12 V or 0-10 V heating circuit 2; output actual value, setpoint and max. setpoint of the segment with 1-9V (0-Tmax). The range outside these limits should be considered an invalid signal. Contactor actuation via converter relay
9	-

23 Nabertherm Service



The Nabertherm Service team is available at all times for furnace maintenance and repair. If you have any questions, problems, or requirements, contact Nabertherm GmbH. By mail, phone, or the Internet.

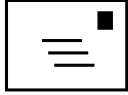

Mail

Nabertherm GmbH
Bahnhofstrasse 20
28865 Lilienthal/Germany



Phone or fax

Phone: +49 (4298) 922-333
Fax: +49 (4298) 922-129



Web or e-mail

www.nabertherm.com
contact@nabertherm.de

When you contact us, please have the type plate details of the furnace or controller at hand.

Provide the following details from the type plate:

Nabertherm GmbH Bahnhofstr. 20, 28865 Lilienthal/Bremen, Germany Tel +49 (04298) 922-0, Fax +49 (04298) 922-129 contact@nabertherm.de www.nabertherm.com		
①	②	④
③		

- ① Furnace model
- ② Serial number
- ③ Article number
- ④ Year of construction

Fig. 18: Example (type plate)

24 For Your Notes



MORE THAN HEAT 30-3000 °C

Headquarters:

Nabertherm GmbH · Bahnhofstr. 20 · 28865 Lilienthal/Bremen, Germany · Tel +49 (4298) 922-0, Fax -129 · contact@nabertherm.de · www.nabertherm.com

Reg: M03.0022 ENGLISCH